

# BILLET

SYMMETRICAL BAFFLES INTEGRAL - WET LOCATION

**bold**  
lighting



The Billet family of products allows you to achieve uniformity throughout indoor and outdoor spaces while maintaining the same optical performance, light consistency, and overall aesthetics.

The Billet Symmetrical Baffles were designed to provide unmatched performance while maintaining minimal glare. The Billet confidently delivers a flawless light distribution and a beautifully finished product.

## CONSTRUCTION

**Product Type :** Linear  
**Body Material :** Extruded Aluminum  
**Body Finish :** Black / Grey / White  
Custom RAL

**IP Rating :** IP67 Inground  
IP66 Ceiling Recessed

**IK Rating :** IK10

**Drive Over Rating :** Billet Inground is designed to bear static loads up to 2500 lbs. from vehicles with pneumatic tires. This product is not intended to be used for traffic lanes.  
**Chicago plenum rated**

## INSTALLATION

**Environment :** Wet Location  
**Mounting :** Surface Mounted / Pendant  
Ceiling Recessed (Trim & Trimless)  
Wall Recessed (Trim & Trimless)  
Inground

## OPTICS

**Optical Distribution :** 10° / 20° / 28° / 50°  
Elliptical (10°x28°) / (10°x36°)  
**Glare Control :** UGR<10

## LIGHT SOURCE

**Direct Light Source :** Hi-power LEDs  
**Luminous Output :** from 1385lm/m to 5310lm/m (Delivered)  
**Light Source CCT :** 2700K / 3000K / 3500K  
4000K / Tunable White (2700K-5000K)  
Dim-to-Warm (3000K-1800K) / RGBW  
**Color Rendering Index :** Ra90  
**Lifetime :** L80 B10 @ 70,000 Hrs

## ELECTRICAL

**Input Voltage :** 220-240V / UNV 120-277V - 50Hz/60Hz  
**Load :** 16W/m to 66W/m  
**Output Type :** Constant Current  
**Driver Type :** Integral  
**Dimming :** 0-10V / DALI / ELV / DMX  
Lutron Hi-Lume  
**Code Compliance :** ETL / CSA / CE

Series	Mounting	Nominal Length <sup>1</sup>
<b>BOS</b>	R Recessed with Trim	12 300 mm
	T Recessed Trimless*	24 600 mm
	S Surface Mounted	36 900 mm
	P Pendant	48 1200 mm
	I Inground*	60 1500 mm
		XX Custom mm

\* For Inground "I" and Recessed Trimless "T" mountings, the housings will show on the price quote and order as a separate item to allow us to ship them ahead of the fixtures if required by the contractor.

For custom lengths and shapes, consult factory.  
For exact lengths refer to dimensions table.

Code example: **BOS**-P12W-L2B-W-E927-0

Body Finish	Output	Voltage	Dimming	Baffles	Beam Angle	CRI	Color Temp	Emergency
<b>B</b> Black	<b>L<sup>2</sup></b> 1580lm/m (16W)	<b>2</b> 220-240V	<b>A</b> No Dimming	<b>W</b> Flat White	<b>S</b> 10°	<b>9</b> +90	<b>27</b> 2700K	<b>0</b> No
<b>G</b> Grey	<b>M<sup>2</sup></b> 2740lm/m (33W)	<b>U<sup>6</sup></b> Universal 120 to 277V	<b>B</b> 0-10V to 1%	<b>B</b> Flat Black	<b>M</b> 20°		<b>30</b> 3000K	
<b>W</b> White	<b>H<sup>2</sup></b> 3845lm/m (49W)		<b>D</b> DALI to 1%	<b>N</b> Black Nickel	<b>F</b> 28°		<b>35</b> 3500K	
<b>X</b> Custom RAL	<b>V<sup>2</sup></b> 4960lm/m (66W)		<b>E</b> ELV Dimming	<b>C</b> Specular Chrome	<b>B</b> 50°		<b>40</b> 4000K	
	<b>D<sup>3</sup></b> 1500m/m (26W)		<b>F</b> DMX	<b>E</b> Diffuse Gold	<b>E</b> 10°x 28°		<b>WD</b> 3000K-1800K	
	<b>W<sup>3</sup></b> 4265lm/m (59W)		<b>G<sup>7</sup></b> LUTRON	<b>X</b> Custom	<b>G</b> 10°x 36°		<b>TW</b> 2700K - 5000K	
	<b>U<sup>4</sup></b> 2325lm/m (33W)						<b>CC<sup>8</sup></b> RGBW	
	<b>A<sup>4</sup></b> 4265lm/m (66W)							
	<b>C<sup>5</sup></b> 3585lm/m (66W)							

Notes:  
<sup>1</sup> 150 mm length increments available as a modification.  
<sup>2</sup> Denotes output at 3000K, unless otherwise noted.  
<sup>3</sup> Denotes output specific to Dim-to-Warm at 3000K.  
<sup>4</sup> Denotes output specific to Tunable White at full on.  
<sup>5</sup> Denotes RGBW (C) output with all colors at full power.  
<sup>6</sup> Not applicable for ELV dimming.  
<sup>7</sup> Hi-lume, Vive, and Athena compatible.  
<sup>8</sup> Only available with DMX dimming.

Consult factory for lead-times.  
Consult factory for systems using multiple optics and mounting configurations.



**Bold Lighting**  
4710 Ecton Dr., Marietta, GA 30066, USA  
info@boldlighting.us www.boldlighting.us t: +1-678-903-4061

# OPTICAL FLEXIBILITY

## NARROW BEAM SYMMETRICAL BAFFLE

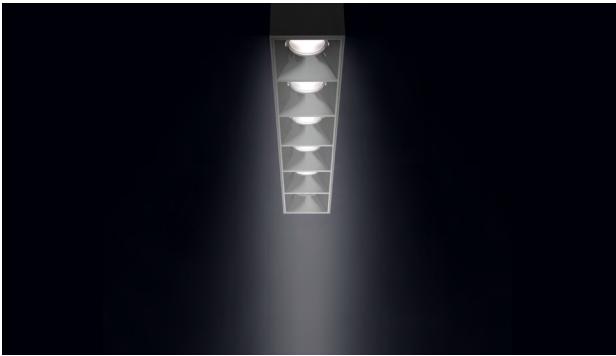

10° Beam Angle

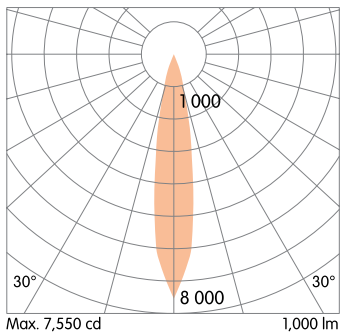

A narrow 10° beam is ideal for high-ceiling applications and for emphasizing texture on vertical surfaces and architectural elements.

## MEDIUM BEAM SYMMETRICAL BAFFLE



25° Beam Angle

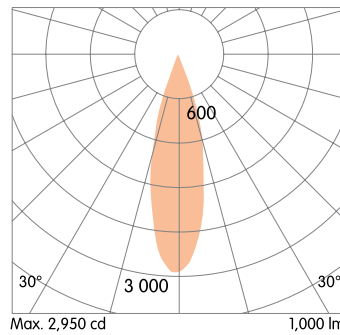

The 25° medium beam is a versatile distribution that works in a wide range of applications and spaces. This optic is a nice balance between light punch and ambient uniformity.

## FLOOD BEAM SYMMETRICAL BAFFLE



40° Beam Angle

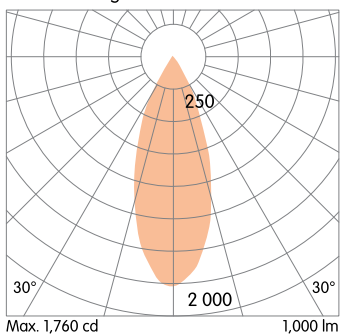

A 40° flood beam is the optimal option for achieving efficient ambient lighting with excellent uniformity and very low glare.

## ELLIPTICAL DISTRIBUTION



Elliptical Beam Angle

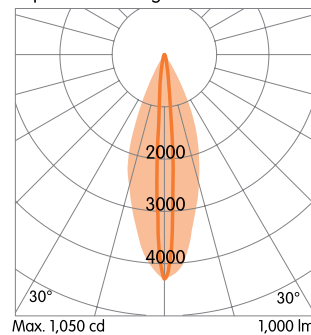

Elliptical distributions can be used anywhere focused illumination is needed. Billet's elliptical beam is ideal for applications such as grazing texture on vertical surfaces and illuminating long narrow spaces without scallops.

**MOUNTING FLEXIBILITY**  
Per Millimeter

**SURFACE MOUNTED**



Actual (mm)  
L= 622 | 922 | 1222 | 1522 |  
Continuous runs  
W= 72  
H= 91

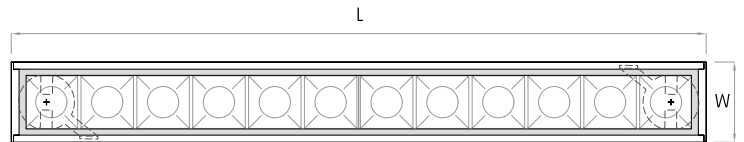
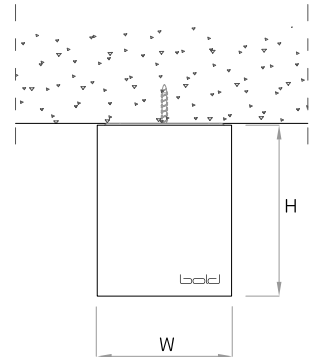

**RECESSED WITH TRIM**

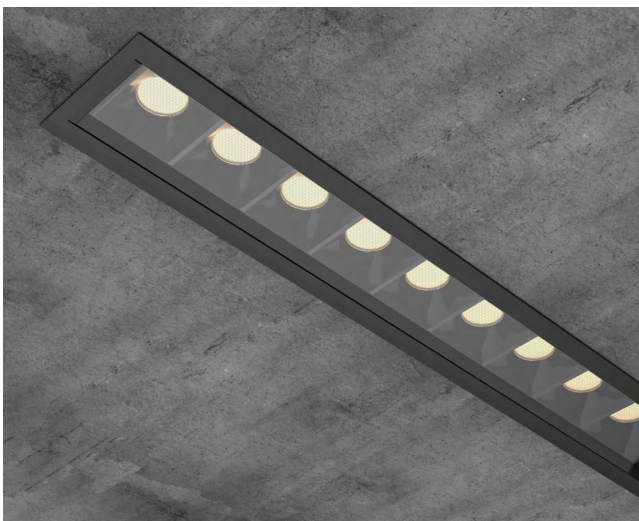

 (L-20 x W-20)

Actual (mm)  
L= 334 | 634 | 934 | 1234 |  
1534 | Continuous runs  
W= 80  
H= 91

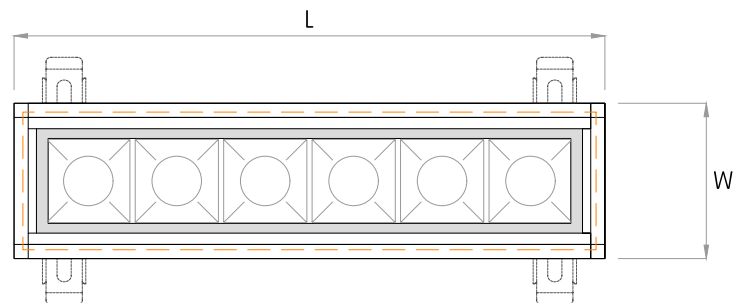
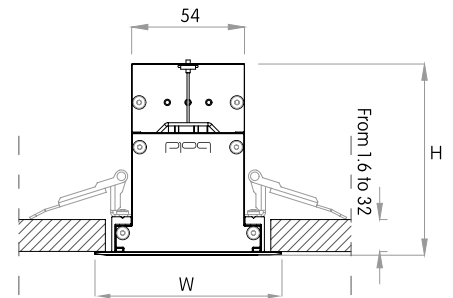

**MOUNTING FLEXIBILITY**  
Per Millimeter

**RECESSED TRIMLESS**



 (L+1.6 x W+1.6)

Actual (mm)  
L= 624 | 924 | 1224 | 1524 |  
Continuous runs  
W= 75  
H= 97

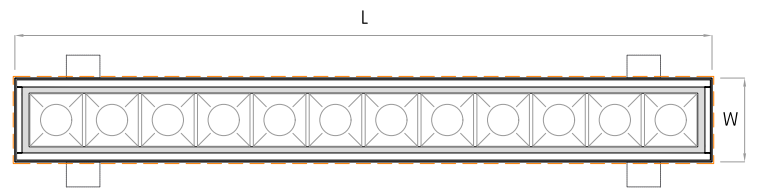
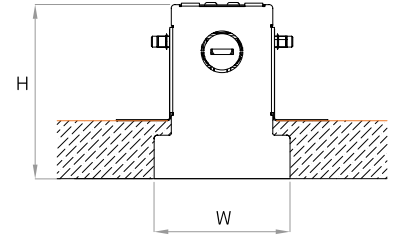

**INGROUND**

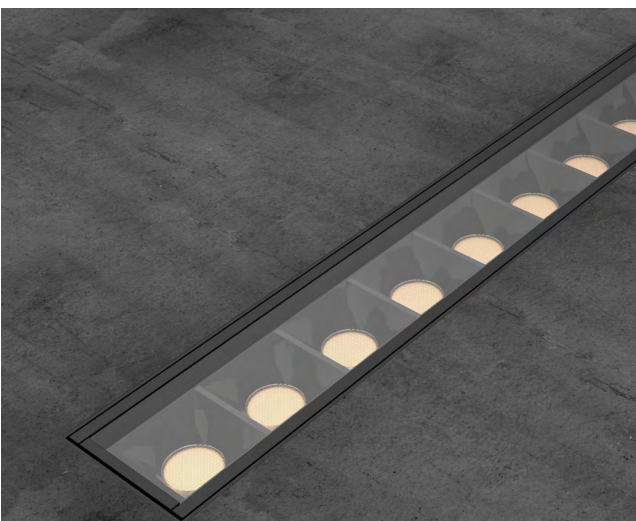

Actual (mm)  
L= 325 | 625 | 925 | 1225 |  
1525 | Continuous runs  
W1= 77 | W2= 95  
H= 92

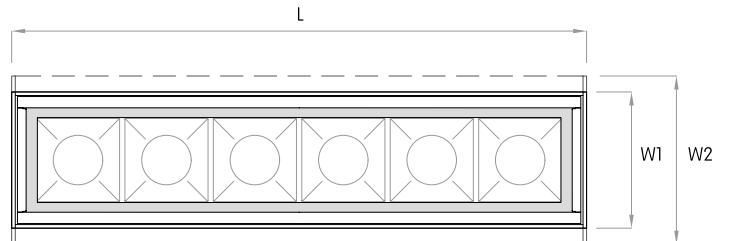
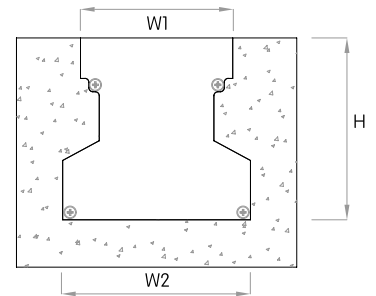

**MOUNTING FLEXIBILITY**  
Per Millimeter

**PENDANT**



Actual (mm)  
L= 622 | 922 | 1222 | 1522 |  
Continuous runs  
W= 72  
H= 91  
X= 1500

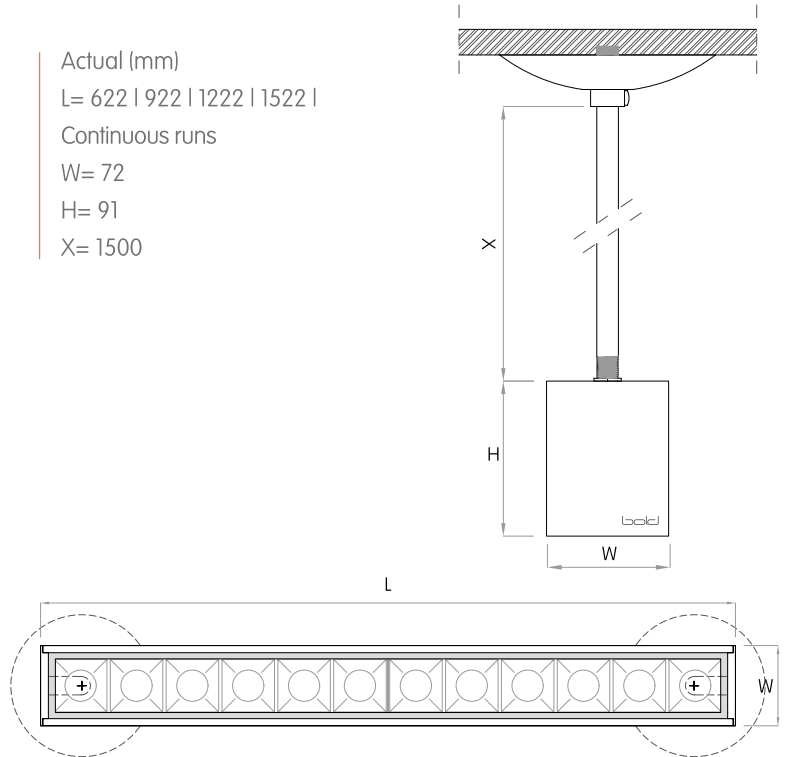



## DELIVERED LUMEN OUTPUT

Per Meter

Output Watts CRI +90

STATIC-WHITE		2700K	3000K	3500K	4000K
L	16W	1385 lm	1580 lm	1495 lm	1525 lm
M	33W	2585 lm	2740 lm	2790 lm	2840 lm
H	49W	3760 lm	3845 lm	4065 lm	4140 lm
V	66W	4830 lm	4960 lm	5215 lm	5310 lm

DIM-TO-WARM 3000K-1800K		3000K			
D	26W	1500 lm			
W	59W	4265 lm			

TUNABLE WHITE 2700K-5000K		2700K	5000K		
U	33W	2325 lm	2325 lm		
A	66W	4265 lm	4265 lm		

RGBW		R	G	B	W
TOTAL	66W	2205 lm	3585 lm	555 lm	3415 lm

## DIMENSIONS TABLE

		12"		24"		36"		48"		60"				
		Height		Width		Actual Length								
Surface Mounted	mm	inch	mm	inch	mm	inch	mm	inch	mm	inch	mm	inch	mm	inch
		91	3 9/16	72	2 13/16			622	24 1/2	922	36 5/16	1222	48 1/8	1522
Recessed with Trim	91	3 9/16	88	3 7/16	335	13 3/16	634	25	934	36 13/16	1234	48 5/8	1534	60 7/16
Recessed Trimless	97	3 13/16	75	2 15/16			624	24 5/8	924	36 3/8	1224	48 1/4	1524	60
Pendant	91	3 9/16	72	2 13/16			622	24 1/2	922	36 5/16	1222	48 1/8	1522	59 15/16
Inground (with housing)	92	3 5/8	95	3 3/4	325	12 13/16	625	24 5/8	925	36 7/16	1225	48 1/4	1525	60

