

# BILLET

WALLGRAZER INTEGRAL - WET LOCATION

**bold**  
lighting



The Billet family of products allows you to achieve uniformity throughout indoor and outdoor spaces while maintaining the same optical performance, light consistency, and overall aesthetics.

The Billet Wallgrazer delivers unmatched vertical illumination with virtually zero glare. The Billet confidently delivers a flawless light distribution and a beautifully finished product.

## CONSTRUCTION

**Product Type :** Linear  
**Body Material :** Extruded Aluminum  
**Body Finish :** Black / Grey / White  
 Custom RAL

**IP Rating :** IP67 Inground  
 IP66 Ceiling Recessed  
**IK Rating :** IK10

**Drive Over Rating :** Billet Inground is designed to bear static loads up to 2500 lbs. from vehicles with pneumatic tires. This product is not intended to be used for traffic lanes.  
**Chicago plenum rated**

## INSTALLATION

**Environment :** Wet Location  
**Mounting :** Inground / Ceiling Recessed (Trim & Trimless) / Wall Recessed (Trim & Trimless) / Surface Mounted Wall Mounted / Pendant

## OPTICS

**Optical Distribution :** Wallgraze  
**Glare Control :** UGR<19

## LIGHT SOURCE

**Direct Light Source :** Hi-power LEDs  
**Luminous Output :** from 1270lm/m to 4875lm/m (Delivered)  
**Light Source CCT :** 2700K / 3000K / 3500K 4000K / Tunable White (2700K-5000K)  
 Dim-to-Warm (3000K-1800K) / RGBW  
**Color Rendering Index :** Ra90  
**Lifetime :** L80 B10 @ 70,000 Hrs

## ELECTRICAL

**Input Voltage :** 220-240V / UNV 120-277V - 50Hz/60Hz  
**Load :** 16W/m to 66W/m  
**Output Type :** Constant Current  
**Driver Type :** Integral  
**Dimming :** 0-10V / DALI / ELV / DMX / Lutron Hi-Lume  
**Code Compliance :** ETL / CSA / CE

Code example: **BOW**-P12W-L2B-W-G927-0

Series	Mounting	Nominal Length <sup>1</sup>
<b>BOW</b>	<b>R</b> Recessed with Trim	<b>12</b> 300 mm
	<b>T</b> Recessed Trimless*	<b>24</b> 600 mm
	<b>S</b> Surface Mounted	<b>36</b> 900 mm
	<b>P</b> Pendant	<b>48</b> 1200 mm
	<b>I</b> Inground*	<b>60</b> 1500 mm
	<b>W</b> Wall Mounted	<b>XX</b> Custom mm
	*For Inground "I" and Recessed Trimless "T" mountings, the housings will show on the price quote and order as a separate item to allow us to ship them ahead of the fixtures if required by the contractor.	

Body Finish	Output	Voltage	Dimming	Baffles	Beam Angle	CRI	Color Temp	Emergency
<b>B</b> Black	<b>L<sup>2</sup></b> 1450lm/m (16W)	<b>2</b> 220-240V	<b>A</b> No Dimming	<b>W</b> Flat White	<b>G</b> Grazer	<b>9</b> +90	<b>27</b> 2700K	<b>0</b> No
<b>G</b> Grey	<b>M<sup>2</sup></b> 2515lm/m (33W)	<b>U<sup>6</sup></b> Universal 120 to 277V	<b>B</b> 0-10V to 1%	<b>B</b> Flat Black			<b>30</b> 3000K	
<b>W</b> White	<b>H<sup>2</sup></b> 3530lm/m (49W)		<b>D</b> DALI to 1%	<b>N</b> Black Nickel			<b>35</b> 3500K	
<b>X</b> Custom RAL	<b>V<sup>2</sup></b> 4555lm/m (66W)		<b>E</b> ELV Dimming	<b>C</b> Specular Chrome			<b>40</b> 4000K	
	<b>D<sup>3</sup></b> 1375lm/m (26W)		<b>F</b> DMX	<b>E</b> Diffuse Gold			<b>WD</b> 3000K-1800K	
	<b>W<sup>3</sup></b> 3915lm/m (59W)		<b>G<sup>7</sup></b> LUTRON	<b>X</b> Custom			<b>TW</b> 2700K - 5000K	
	<b>U<sup>4</sup></b> 2130lm/m (33W)						<b>CC<sup>8</sup></b> RGBW	
	<b>A<sup>4</sup></b> 3915lm/m (66W)							
	<b>C<sup>5</sup></b> 3290lm/m (66W)							

Notes:  
<sup>1</sup> 150 mm length increments available as a modification.  
<sup>2</sup> Denotes output at 3000K, unless otherwise noted.  
<sup>3</sup> Denotes output specific to Dim-to-Warm at 3000K.  
<sup>4</sup> Denotes output specific to Tunable White at full on.  
<sup>5</sup> Denotes RGBW (C) output with all colors at full power.  
<sup>6</sup> Not applicable for ELV dimming.  
<sup>7</sup> Hi-lume, Vive, and Athena compatible.  
<sup>8</sup> Only available with DMX dimming.

Consult factory for lead-times.  
 Consult factory for systems using multiple optics and mounting configurations.



**Bold Lighting**  
 4710 Ecton Dr., Marietta, GA 30066, USA  
 info@boldlighting.us www.boldlighting.us t: +1-678-903-4061

# OPTICAL FLEXIBILITY

## BAFFLED WALLGRAZER



Billet wallgrazer delivers maximum performance for emphasizing textured and rough vertical surfaces. The standard output illuminates walls up to 355mm-0mm with outstanding transversal and longitudinal glare control.

15° Wallgrazer

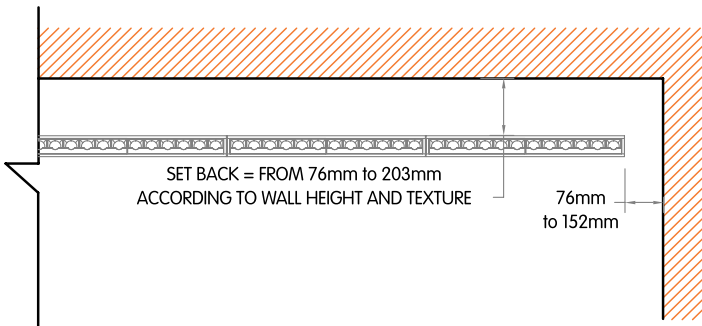
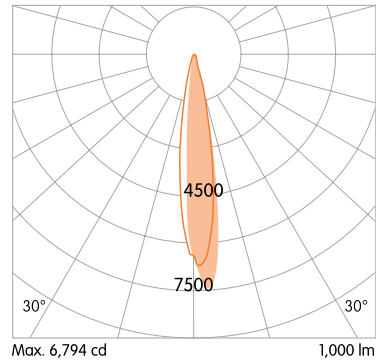

**MOUNTING FLEXIBILITY**  
Per Millimeter

**SURFACE MOUNTED**



Actual (mm)  
L= 622 | 922 | 1222 | 1522 |  
Continuous runs  
W= 72  
H= 91

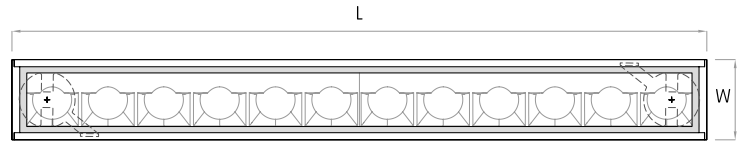
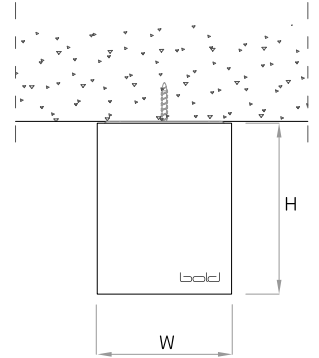

**RECESSED WITH TRIM**



 (L-20 x W-20)

Actual (mm)  
L= 334 | 634 | 934 | 1234 |  
1534 | Continuous runs  
W= 80  
H= 91

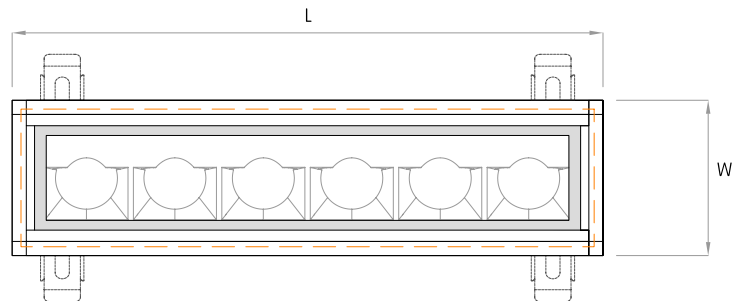
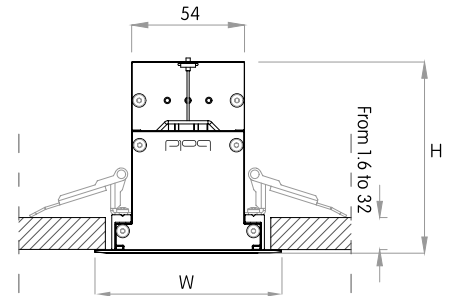

**MOUNTING FLEXIBILITY**  
Per Millimeter

**RECESSED TRIMLESS**



 (L+1.6 x W+1.6)

Actual (mm)  
L= 624 | 924 | 1224 | 1524 |  
Continuous runs  
W= 75  
H= 97

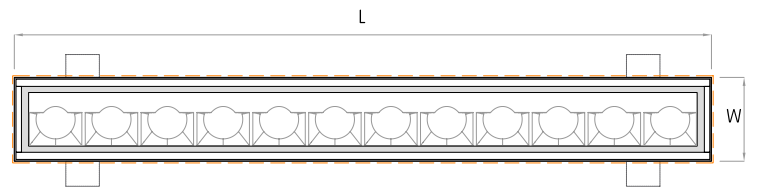
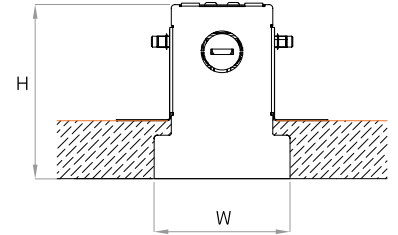

**INGROUND**

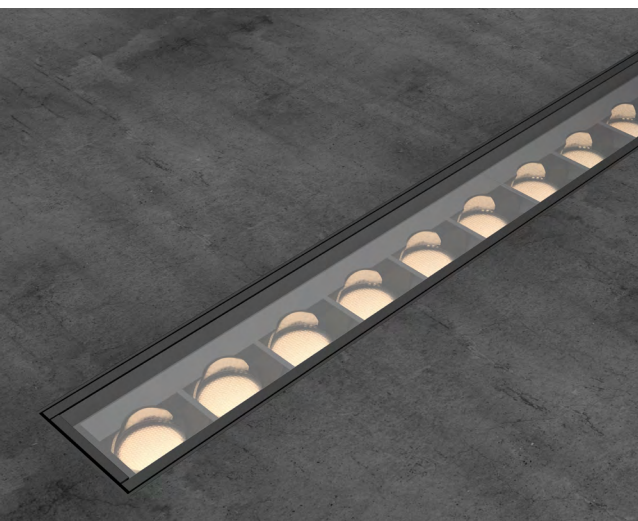

Actual (mm)  
L= 325 | 625 | 925 | 1225 |  
1525 | Continuous runs  
W1= 77 | W2= 95  
H= 92

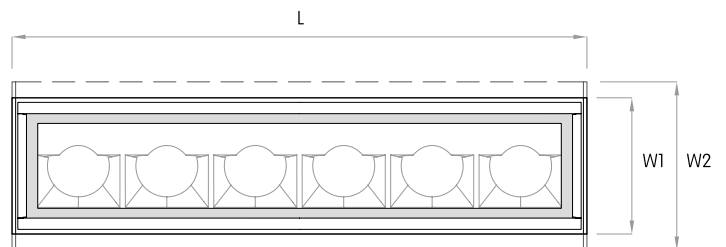
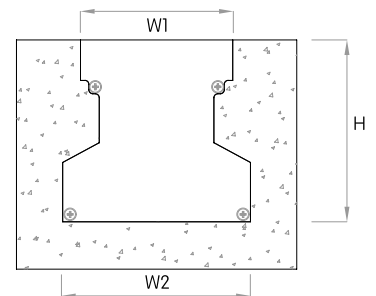

**MOUNTING FLEXIBILITY**  
Per Millimeter

**PENDANT**



Actual (mm)  
L= 622 | 922 | 1222 | 1522 |  
Continuous runs  
W= 72  
H= 91  
X= 1500

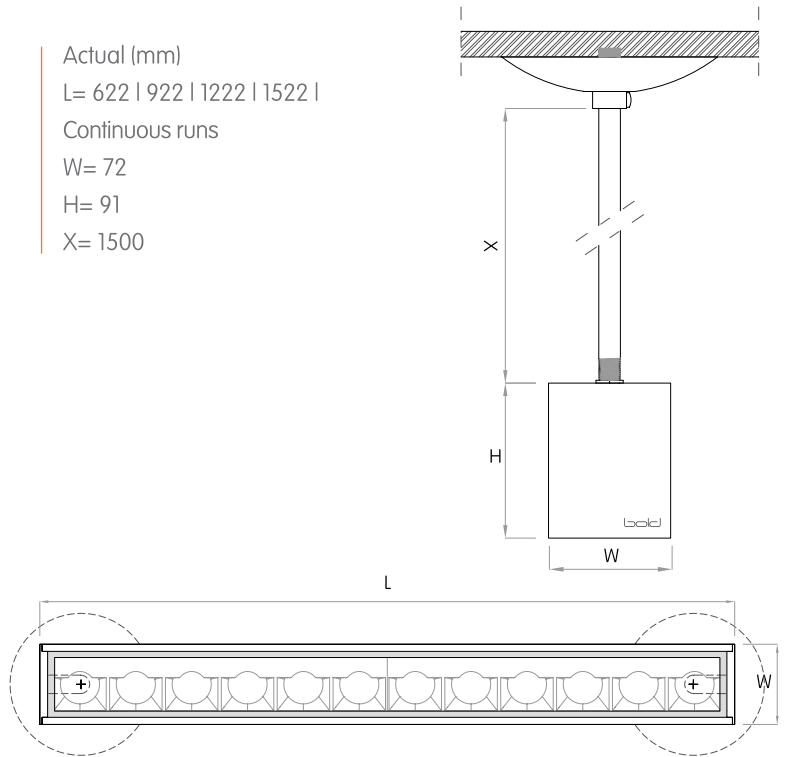

**WALL MOUNTED**



Actual (mm)  
L= 622 | 922 | 1222 | 1522 |  
Continuous runs  
W= 72  
H= 91

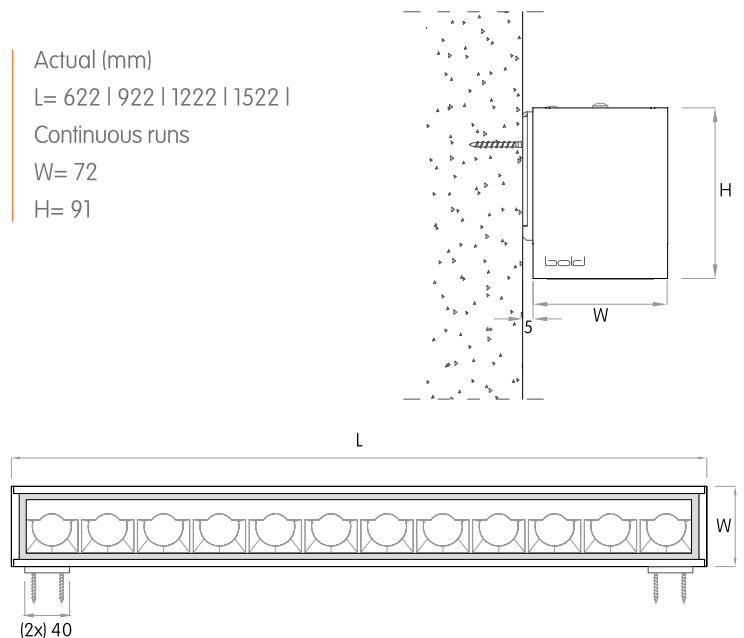

## DELIVERED LUMEN OUTPUT

Per Meter

Output Watts CRI +90

STATIC-WHITE		2700K	3000K	3500K	4000K
L	16W	1270 lm	1450 lm	1370 lm	1400 lm
M	33W	2370 lm	2515 lm	2560 lm	2605 lm
H	49W	3455 lm	3530 lm	3730 lm	3800 lm
V	66W	4430 lm	4555 lm	4785 lm	4875 lm

DIM-TO-WARM 3000K-1800K		3000K			
D	26W	1375 lm			
W	59W	3915 lm			

TUNABLE WHITE 2700K-5000K		2700K	5000K		
U	33W	2130 lm	2130 lm		
A	66W	3915 lm	3915 lm		

RGBW		R	G	B	W
TOTAL	66W	2020 lm	3290 lm	510 lm	3135 lm

## DIMENSIONS TABLE

		12"		24"		36"		48"		60"				
		Height		Width		Actual Length								
Surface Mounted	mm	inch	mm	inch	mm	inch	mm	inch	mm	inch	mm	inch		
		91	3 9/16	72	2 13/16			622	24 1/2	922	36 5/16	1222	48 1/8	1522
Recessed with Trim	91	3 9/16	88	3 7/16	335	13 3/16	634	25	934	36 13/16	1234	48 5/8	1534	60 7/16
Recessed Trimless	97	3 13/16	75	2 15/16			624	24 5/8	924	36 3/8	1224	48 1/4	1524	60
Pendant	91	3 9/16	72	2 13/16			622	24 1/2	922	36 5/16	1222	48 1/8	1522	59 15/16
Inground (with housing)	92	3 5/8	95	3 3/4	325	12 13/16	625	24 5/8	925	36 7/16	1225	48 1/4	1525	60
Wall Mounted	91	3 9/16	72	2 13/16			622	24 1/2	922	36 5/16	1222	48 1/8	1522	59 15/16

