

BILLET

HONEYCOMB INTEGRAL - WET LOCATION

bold
lighting



The Billet family of products allows you to achieve uniformity throughout indoor and outdoor spaces while maintaining the same optical performance, light consistency, and overall aesthetics.

The Billet Honeycomb was designed to provide unmatched performance and a decorative aesthetic while maintaining minimal glare. The Billet confidently delivers a flawless light distribution and a beautifully finished product.

CONSTRUCTION

Product Type : Linear
Body Material : Extruded Aluminum
Body Finish : Black / Grey / White
 Custom RAL

IP Rating : IP67 Inground

IP66 Ceiling Recessed

IK Rating : IK10

Drive Over Rating : Billet Inground is designed to bear static loads up to 2500 lbs. from vehicles with pneumatic tires. This product is not intended to be used for traffic lanes. Chicago plenum rated

INSTALLATION

Environment : Wet Location

Mounting : Inground
 Ceiling Recessed (Trim & Trimless)
 Wall Recessed (Trim & Trimless)
 Surface Mounted / Pendant

OPTICS

Optical Distribution : 10° / 20° / 35° / 50°
 Elliptical (10°x40°) (25°x50°)

Glare Control : UGR<19

LIGHT SOURCE

Direct Light Source : Hi-power LEDs

Luminous Output : from 430lm/ft. to 1370lm/ft. (Delivered)

Light Source CCT : 2700K / 3000K / 3500K

4000K / Tunable White (2700K-5000K)

Color Rendering Index : Ra90

Lifetime : L80 B10 @ 70,000 Hrs

ELECTRICAL

Input Voltage : 120V / UNV 120-277V - 50Hz/60Hz

Load : 5W/ft. to 20W/ft.

Output Type : Constant Current

Driver Type : Integral

Dimming : 0-10V / DALI / ELV / DMX / Lutron Hi-Lume

Code Compliance : ETL / CSA / CE

Series	Mounting	Nominal Length ¹
BHS	R Recessed with Trim	12 12"
	T Recessed Trimless*	24 24"
	S Surface Mounted	36 36"
	P Pendant	48 48"
	I Inground*	60 60"
		XX Custom in

* For Inground "I" and Recessed Trimless "T" mountings, the housings will show on the price quote and order as a separate item to allow us to ship them ahead of the fixtures if required by the contractor.

For custom lengths and shapes, consult factory.
 For exact lengths refer to dimensions table.

Code example: **BHS**-P12W-L1B-W-E927-0

Body Finish	Output	Voltage	Dimming	Baffles	Beam Angle	CRI	Color Temp	Emergency
B Black	L² 430lm/ft (5W)	1 120V	A No Dimming	W Flat White	S 10°	9 +90	27 2700K	0 No
G Grey	M² 745lm/ft (10W)	U⁴ Universal 120 to 277V	B 0-10V to 1%	B Flat Black	M 20°		30 3000K	
W White	H² 1030lm/ft (15W)		D DALI to 1%	N Black Nickel	F 35°		35 3500K	
X Custom RAL	V² 1370lm/ft (20W)		E ELV Dimming	C Specular Chrome	W 50°		40 4000K	
	U³ 745lm/ft (10W)		F DMX	E Diffuse Gold	E 10°x 40°		TW 2700K - 5000K	
	A³ 1370lm/ft (20W)	G⁵ LUTRON	X Custom	E 25°x 50°				

Notes:
¹ 6" length increments available as a modification.
² Denotes output at 3000K, unless otherwise noted.
³ Denotes output specific to Tunable White at full on.
⁴ Not applicable for ELV dimming.
⁵ Hi-lume, Vive, and Athena compatible.

Consult factory for lead-times.
 Consult factory for systems using multiple optics and mounting configurations.



Bold Lighting
 4710 Ecton Dr., Marietta, GA 30066, USA
 info@boldlighting.us www.boldlighting.us t: +1-678-903-4061

OPTICAL FLEXIBILITY

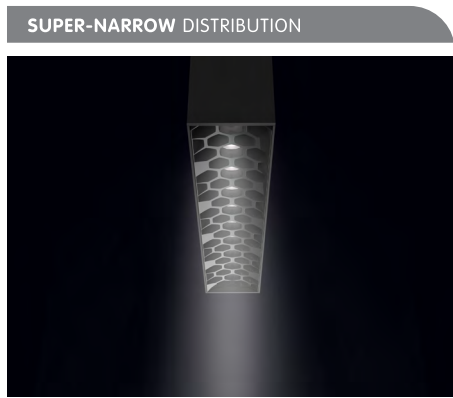

10° Beam Angle

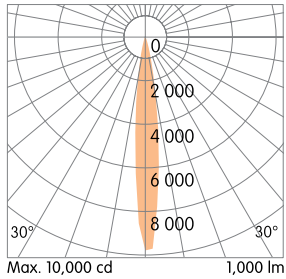

A super-narrow 10° optic is ideal for high-ceiling applications and for emphasizing texture on vertical surfaces and architectural elements.

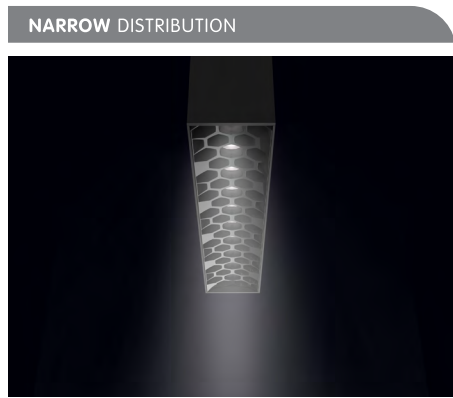

20° Beam Angle

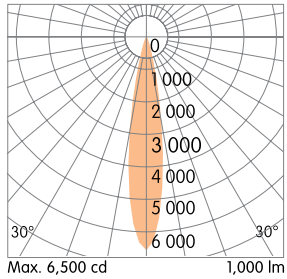

The narrow 20° beam can be used to provide a subtle graze around a perimeter or on vertical surfaces. It is also ideal for general illumination where double or triple height spaces present challenges.

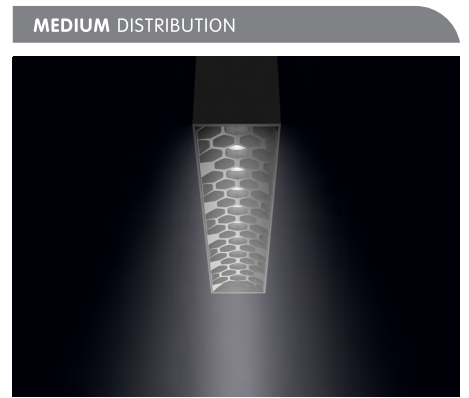

35° Beam Angle

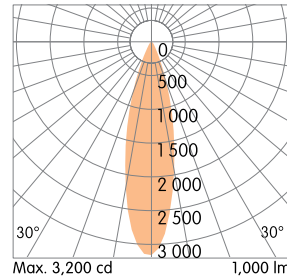

The 35° medium beam is a versatile distribution that can be used in a wide range of spaces and is a good balance between light punch and ambient uniformity.

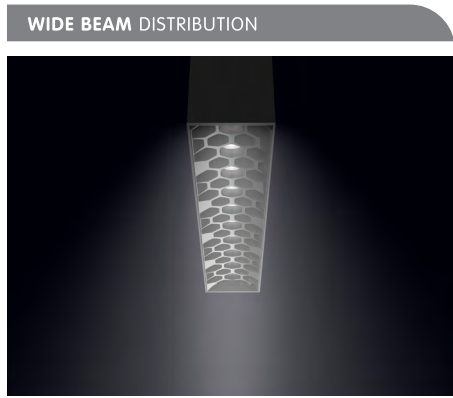

50° Beam Angle

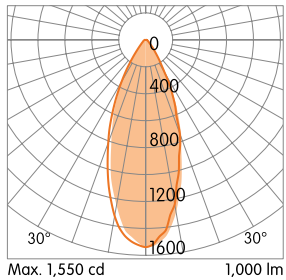

The 50° wide beam is a versatile distribution that can be used in a wide range of spaces and is a good balance between light punch and ambient uniformity.

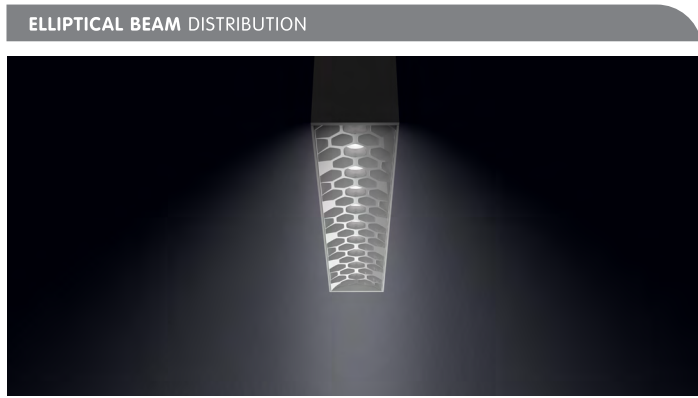

10° x 40° Beam Angle

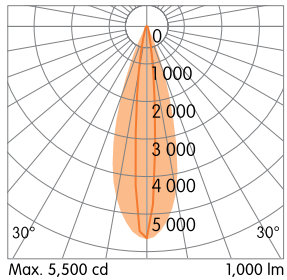

The elliptical beam is optimal for grazing applications and is an effective solution for the illumination of long narrow spaces.

25° x 50° Beam Angle

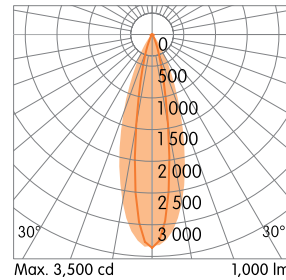

MOUNTING FLEXIBILITY

SURFACE MOUNTED

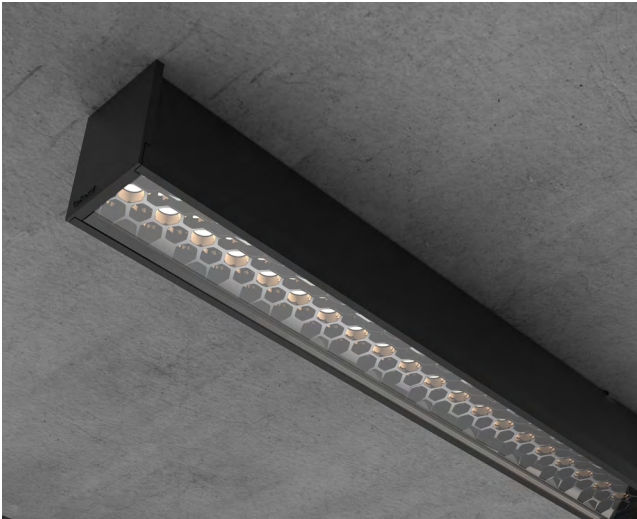

Actual
 L= 24¹/₂" | 36⁵/₁₆" | 48¹/₈" | 59⁵/₁₆" |
 Continuous runs
 W= 2¹³/₁₆"
 H= 3⁹/₁₆"

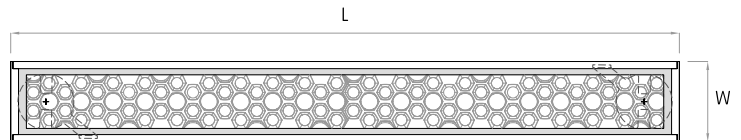
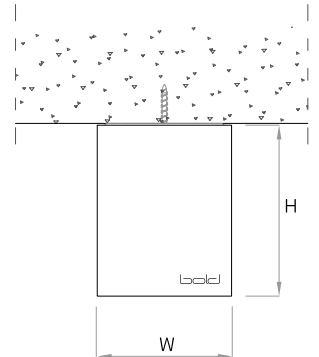

RECESSED WITH TRIM

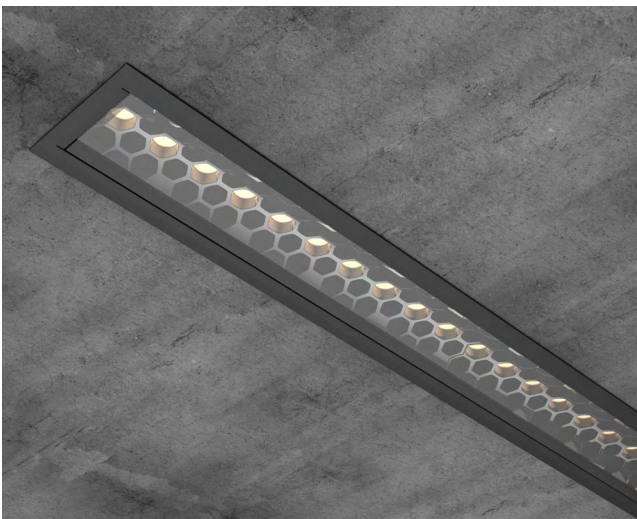

(L-13¹/₁₆" x W-13¹/₁₆")

Actual
 L= 13³/₁₆" | 25" | 36¹³/₁₆" |
 48⁵/₈" | 60⁷/₁₆" |
 Continuous runs
 W= 3⁷/₁₆"
 H= 3⁹/₁₆"

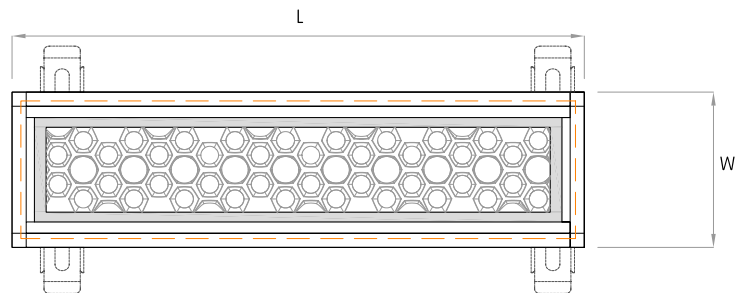
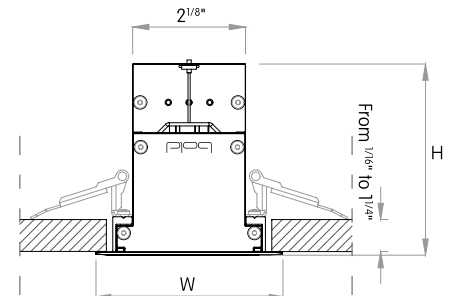

MOUNTING FLEXIBILITY

RECESSED TRIMLESS



$$\text{Trimless} \quad (L + 1/16'' \times W + 1/16'')$$

Actual
 $L = 24^{5/8}'' \mid 36^{3/8}'' \mid 48^{1/4}'' \mid 60'' \mid$
 Continuous runs
 $W = 2^{15/16}''$
 $H = 3^{13/16}''$

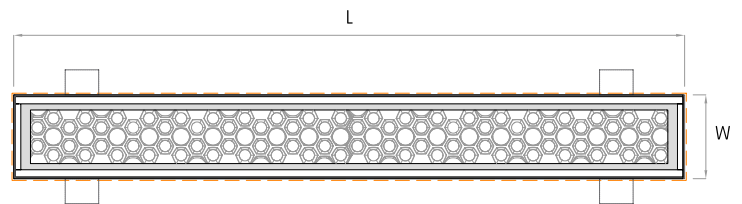
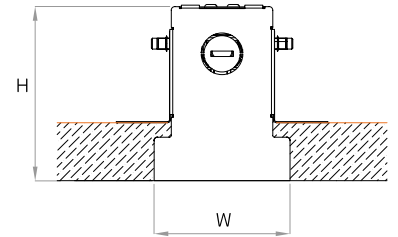

INGROUND

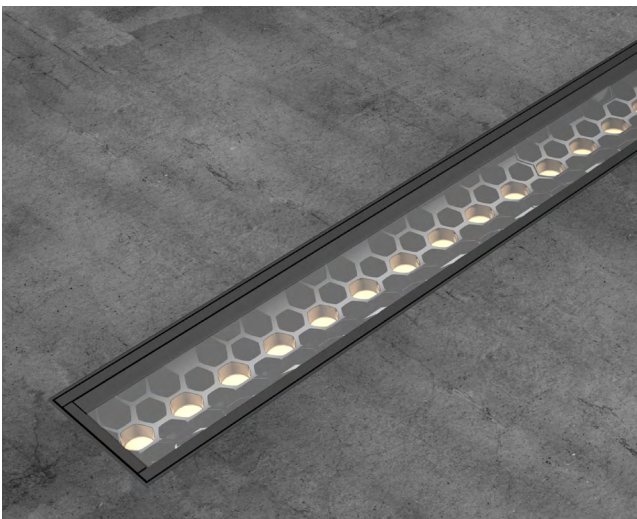

Actual
 $L = 12^{13/16}'' \mid 24^{5/8}'' \mid 36^{7/16}'' \mid$
 $48^{1/4}'' \mid 60'' \mid$
 Continuous runs
 $W1 = 3'' \mid W2 = 3^{3/4}''$
 $H = 3^{5/8}''$

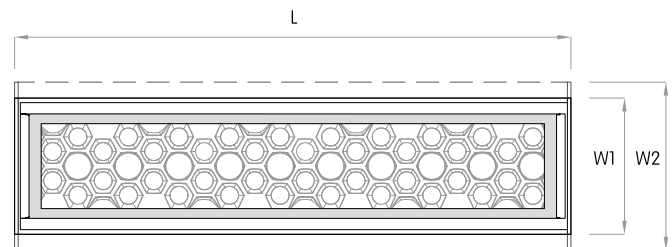
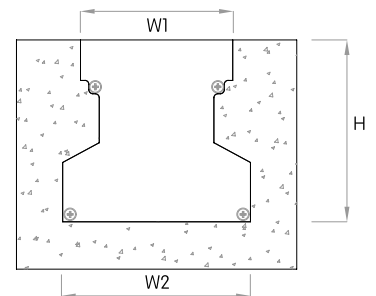

MOUNTING FLEXIBILITY

PENDANT



Actual

L= 24¹/₂" | 36⁵/₁₆" | 48¹/₈" | 59¹⁵/₁₆" |

Continuous runs

W= 2¹³/₁₆"

H= 3⁹/₁₆"

X= up to 59"

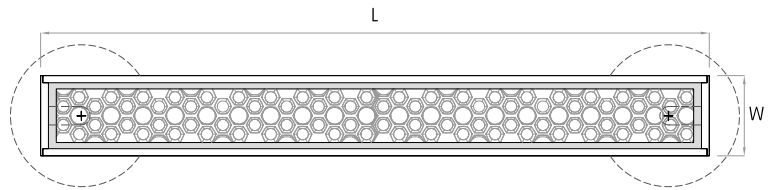
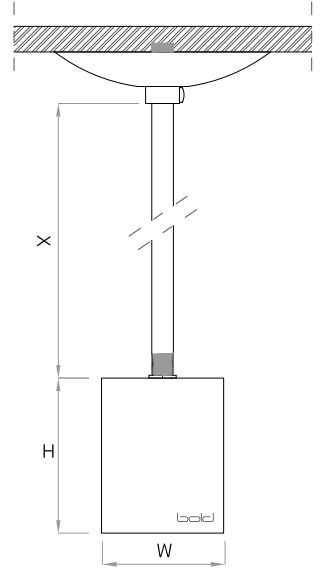

DELIVERED LUMEN OUTPUT

Per Linear Foot

Output Watts CRI +90

STATIC-WHITE		2700K	3000K	3500K	4000K
L	5W	430 lm	430 lm	430 lm	430 lm
M	10W	745 lm	745 lm	745 lm	745 lm
H	15W	1030 lm	1030 lm	1030 lm	1030 lm
V	20W	1370 lm	1370 lm	1370 lm	1370 lm

TUNABLE WHITE 2700K-5000K		2700K	5000K
U	10W	745 lm	745 lm
A	20W	1370 lm	1370 lm

DIMENSIONS TABLE

		12"		24"		36"		48"		60"				
		Height		Width		Actual Length								
		mm	Inch	mm	Inch	mm	Inch	mm	Inch	mm	Inch	mm	Inch	
		Surface Mounted	91	3 9/16	72	2 13/16			622	24 1/2	922	36 5/16	1222	48 1/8
Recessed with Trim	91	3 9/16	88	3 7/16	335	13 3/16	634	25	934	36 13/16	1234	48 5/8	1534	60 7/16
Recessed Trimless	97	3 13/16	75	2 15/16			624	24 5/8	924	36 3/8	1224	48 1/4	1524	60
Pendant	91	3 9/16	72	2 13/16			622	24 1/2	922	36 5/16	1222	48 1/8	1522	59 15/16
Inground (with housing)	92	3 5/8	95	3 3/4	325	12 13/16	625	24 5/8	925	36 7/16	1225	48 1/4	1525	60

