

BILLET

OPAL INTEGRAL - WET LOCATION

bold
lighting



The Billet family of products allows you to achieve uniformity throughout indoor and outdoor spaces while maintaining the same optical performance, light consistency, and overall aesthetics.

The Billet Opal delivers bold vertical and horizontal illumination perfect for ambient lighting and washing. The Billet confidently delivers a flawless light distribution and a beautifully finished product.

CONSTRUCTION

Product Type : Linear
Body Material : Extruded Aluminum
Body Finish : Black / Grey / White
 Custom RAL

IP Rating : IP67 Inground

IP66 Ceiling Recessed

IK Rating : IK10

Drive Over Rating : Billet Inground is designed to bear static loads up to 2500 lbs. from vehicles with pneumatic tires. This product is not intended to be used for traffic lanes. Chicago plenum rated

INSTALLATION

Environment : Wet Location

Mounting : Inground / Ceiling Recessed (Trim & Trimless) / Wall Recessed (Trim & Trimless) / Wall Mounted Surface Mounted / Pendant

OPTICS

Optical Distribution : Lambertian

Glare Control : UGR<19

LIGHT SOURCE

Direct Light Source : Mid-Power LEDs

Luminous Output : from 300lm/ft. to 1275lm/ft. (Delivered)

Light Source CCT : 2700K / 3000K / 3500K 4000K / Tunable White (2700K-5000K)

Color Rendering Index : Ra90

Lifetime : L80 B10 @ 70,000 Hrs

ELECTRICAL

Input Voltage : 120V / UNV 120-277V - 50Hz/60Hz

Load : 5W/ft. to 20W/ft.

Output Type : Constant Current

Driver Type : Integral

Dimming : 0-10V / DALI / ELV / DMX

Lutron Hi-Lume

Code Compliance : ETL / CSA / CE

Series	Mounting	Nominal Length ¹
BOO	R Recessed with Trim	12 12"
	T Recessed Trimless*	24 24"
	S Surface Mounted	36 36"
	P Pendant	48 48"
	I Inground*	60 60"
	W Wall Mounted	XX Custom in
	*For Inground "I" and Recessed Trimless "T" mountings, the housings will show on the price quote and order as a separate item to allow us to ship them ahead of the fixtures if required by the contractor.	

Code example: **BOO** - P12W - L1B - W - L927 - 0

Body Finish	Output	Voltage	Dimming	Baffles	Beam Angle	CRI	Color Temp	Emergency
B Black	L² 315lm/ft (5W)	1 120V	A No Dimming	W Flat White	L Opal	9 +90	27 2700K	0 No
G Grey	M² 630lm/ft (10W)	U⁴ Universal 120 to 277V	B 0-10V to 1%	B Flat Black			30 3000K	
W White	H² 950lm/ft (15W)		D DALI to 1%	N Black Nickel			35 3500K	
X Custom RAL	V² 1215lm/ft (20W)		E ELV Dimming	C Specular Chrome			40 4000K	
	U³ 665lm/ft (10W)		F DMX	E Diffuse Gold			TW 2700K - 5000K	
	A³ 1275lm/ft (20W)		G⁵ LUTRON	X Custom				

Notes:

- ¹ 6" length increments available as a modification.
- ² Denotes output at 3000K, unless otherwise noted.
- ³ Denotes output specific to Tunable White at full on.
- ⁴ Not applicable for ELV dimming.
- ⁵ Hi-lume, Vive, and Athena compatible.

Consult factory for lead-times.
 Consult factory for systems using multiple optics and mounting configurations.



Bold Lighting
 4710 Ecton Dr., Marietta, GA 30066, USA
 info@boldlighting.us www.boldlighting.us t: +1-678-903-4061

OPTICAL FLEXIBILITY

LAMBERTIAN DISTRIBUTION

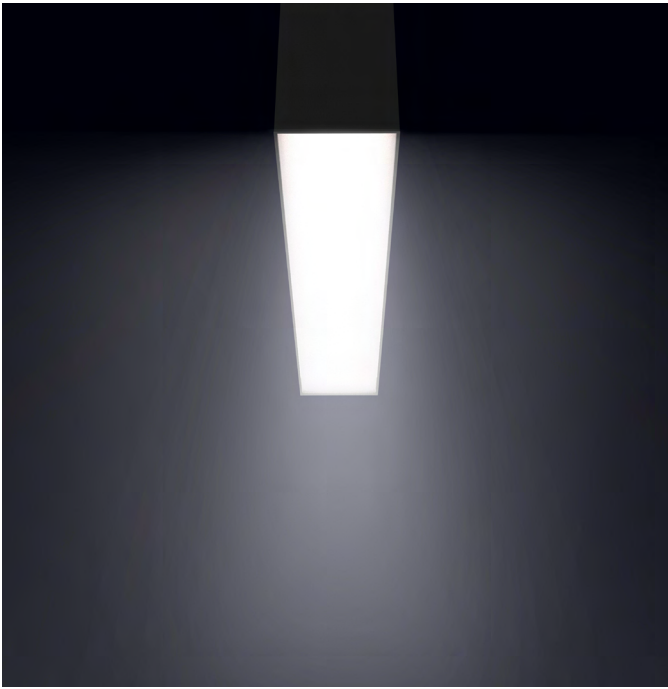

Lambertian distributions are optimal for general lighting, providing a soft and uniform illumination on both horizontal and vertical surfaces.

Billet's opal lens is ideal for commercial, retail, institutional, and any other environment where comfortable and even illumination is needed.

120° Beam Angle (Lambertian)

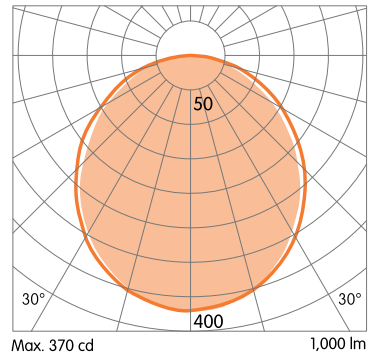

MOUNTING FLEXIBILITY

SURFACE MOUNTED



Actual
 L= 24¹/₂" | 36⁵/₁₆" | 48¹/₈" | 59⁵/₁₆" |
 Continuous runs
 W= 2¹³/₁₆"
 H= 3⁹/₁₆"

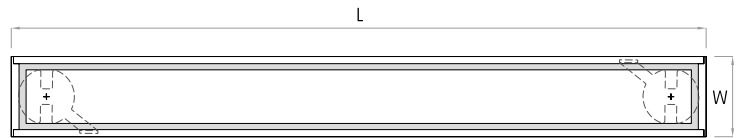
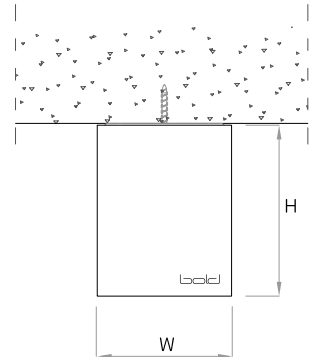

RECESSED WITH TRIM

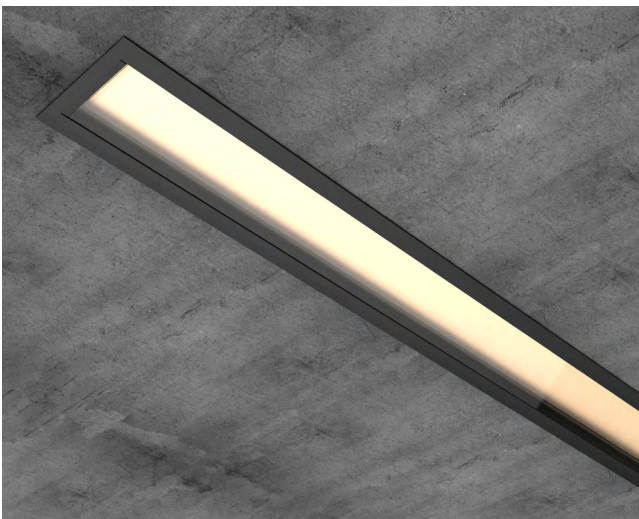

(L-¹³/₁₆" x W-¹³/₁₆")

Actual
 L= 13³/₁₆" | 25" | 36¹³/₁₆" |
 48⁵/₈" | 60⁷/₁₆" |
 Continuous runs
 W= 3⁷/₁₆"
 H= 3⁹/₁₆"

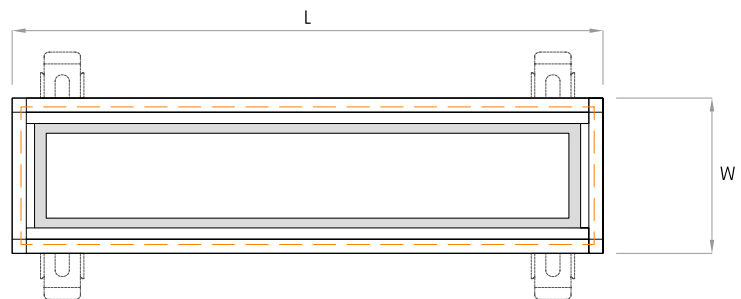
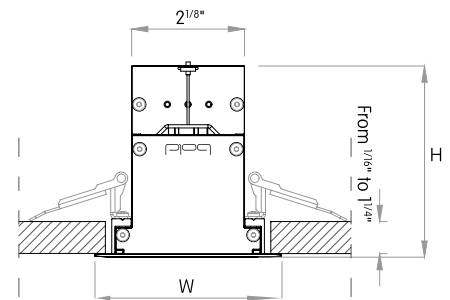

MOUNTING FLEXIBILITY

RECESSED TRIMLESS



$$\text{Trimless} \quad (L + 1/16'' \times W + 1/16'')$$

Actual
 $L = 24^{5/8}'' \mid 36^{3/8}'' \mid 48^{1/4}'' \mid 60'' \mid$
 Continuous runs
 $W = 2^{15/16}''$
 $H = 3^{13/16}''$

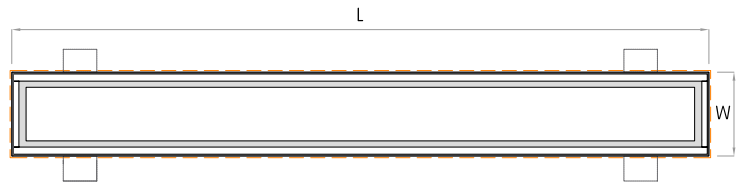
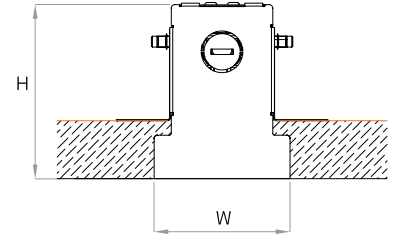

INGROUND

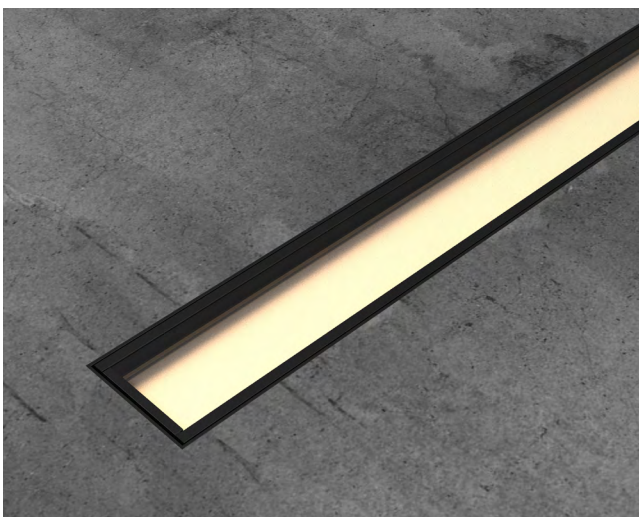

Actual
 $L = 12^{13/16}'' \mid 24^{5/8}'' \mid 36^{7/16}'' \mid$
 $48^{1/4}'' \mid 60'' \mid$
 Continuous runs
 $W1 = 3'' \mid W2 = 3^{3/4}''$
 $H = 3^{5/8}''$

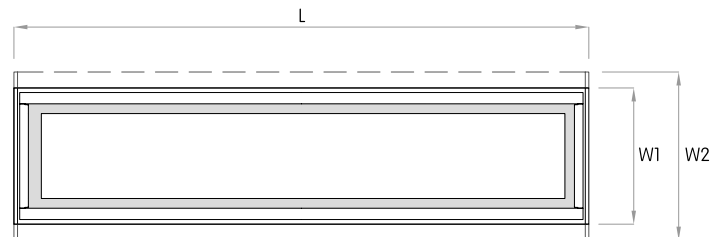
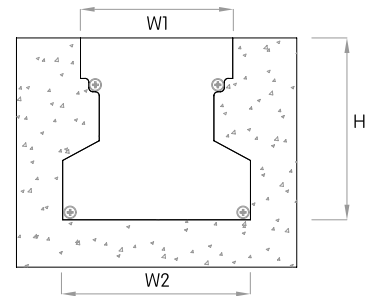

MOUNTING FLEXIBILITY

PENDANT



Actual
L= 24¹/₂" | 36⁵/₁₆" | 48¹/₈" | 59¹⁵/₁₆" |
Continuous runs
W= 2¹³/₁₆"
H= 3⁹/₁₆"
X= 59"

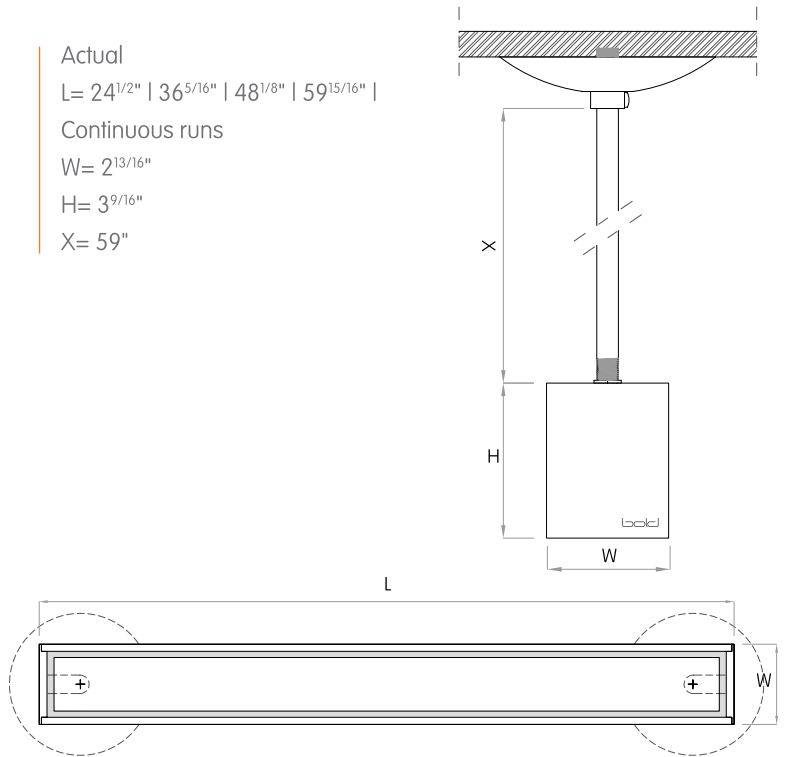

WALL MOUNTED



Actual
L= 24¹/₂" | 36⁵/₁₆" | 48¹/₈" | 59¹⁵/₁₆" |
Continuous runs
W= 2¹³/₁₆"
H= 3⁹/₁₆"

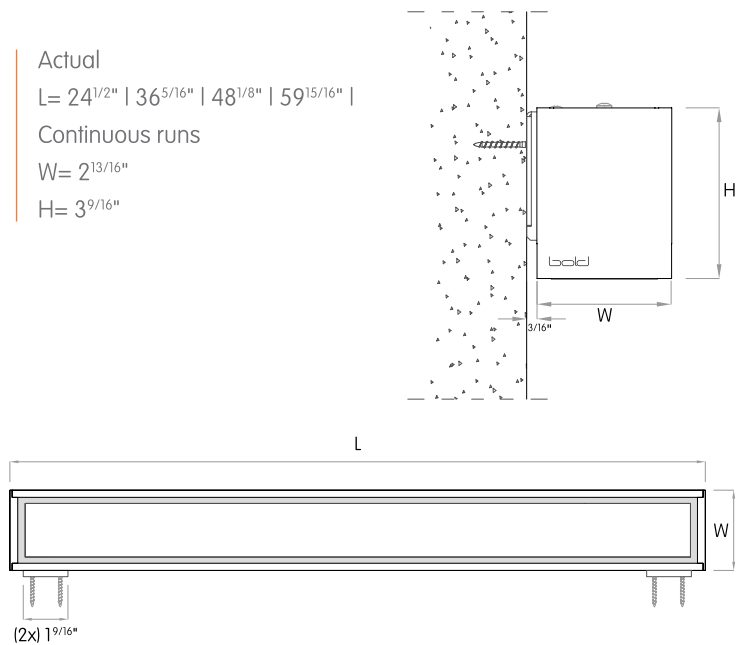

DELIVERED LUMEN OUTPUT

Per Linear Foot

Output Watts CRI +90

STATIC-WHITE		2700K	3000K	3500K	4000K
L	5W	300 lm	315 lm	325 lm	330 lm
M	10W	600 lm	630 lm	650 lm	665 lm
H	15W	900 lm	950 lm	980 lm	995 lm
V	20W	1150 lm	1215 lm	1250 lm	1275 lm

TUNABLE WHITE 2700K-5000K		2700K	5000K
U	10W	600 lm	665 lm
A	20W	1150 lm	1275 lm

DIMENSIONS TABLE

		12"		24"		36"		48"		60"				
		Height		Width		Actual Length								
Surface Mounted	mm	inch	mm	inch	mm	inch	mm	inch	mm	inch	mm	inch		
		91	3 9/16	72	2 13/16			622	24 1/2	922	36 5/16	1222	48 1/8	1522
Recessed with Trim	91	3 9/16	88	3 7/16	335	13 3/16	634	25	934	36 13/16	1234	48 5/8	1534	60 7/16
Recessed Trimless	97	3 13/16	75	2 15/16			624	24 5/8	924	36 3/8	1224	48 1/4	1524	60
Pendant	91	3 9/16	72	2 13/16			622	24 1/2	922	36 5/16	1222	48 1/8	1522	59 15/16
Inground (with housing)	92	3 5/8	95	3 3/4	325	12 13/16	625	24 5/8	925	36 7/16	1225	48 1/4	1525	60
Wall Mounted	91	3 9/16	72	2 13/16			622	24 1/2	922	36 5/16	1222	48 1/8	1522	59 15/16

