

BILLET

SYMMETRICAL BAFFLES REMOTE - WET LOCATION

bold
lighting



The Billet family of products allows you to achieve uniformity throughout indoor and outdoor spaces while maintaining the same optical performance, light consistency, and overall aesthetics.

The Billet Symmetrical Baffles were designed to provide unmatched performance while maintaining minimal glare. The Billet confidently delivers a flawless light distribution and a beautifully finished product.

CONSTRUCTION

Product Type : Linear
Body Material : Extruded Aluminum
Body Finish : Black / Grey / White Custom RAL
IP Rating : IP67 Inground
IP66 Ceiling Recessed
IK Rating : IK10
Drive Over Rating : Billet Inground is designed to bear static loads up to 2500 lbs. from vehicles with pneumatic tires. This product is not intended to be used for traffic lanes.
Chicago plenum rated

INSTALLATION

Environment : Wet Location
Mounting : Surface Mounted / Pendant
 Ceiling Recessed (Trim & Trimless)
 Wall Recessed (Trim & Trimless)
 Inground

OPTICS

Optical Distribution : 10° / 20° / 28° / 50°
 Elliptical (10°x28°) / (10°x36°)
Glare Control : UGR<10

LIGHT SOURCE

Direct Light Source : Hi-power LEDs
Luminous Output : from 420lm/ft. to 1620lm/ft. (Delivered)
Light Source CCT : 2700K / 3000K / 3500K 4000K / Tunable White (2700K-5000K)
 Dim-to-Warm (3000K-1800K)
Color Rendering Index : Ra90
Lifetime : L80 B10 @ 70,000 Hrs

ELECTRICAL

Input Voltage : 120V / UNV 120-277V - 50Hz/60Hz
Load : 5W/ft. to 20W/ft.
Output Type : Constant Voltage
Driver Type : Remote
Dimming : 0-10V / DALI / ELV / DMX
 Lutron Hi-Lume
Code Compliance : ETL / CSA / CE

Series	Mounting	Nominal Length ¹
BOS	R Recessed with Trim	12 12"
	T Recessed Trimless*	24 24"
	S Surface Mounted	36 36"
	P Pendant	48 48"
	I Inground*	60 60"
	XX	Custom in

* For Inground "I" and Recessed Trimless "T" mountings, the housings will show on the price quote and order as a separate item to allow us to ship them ahead of the fixtures if required by the contractor.

For custom lengths and shapes, consult factory.
 For exact lengths refer to dimensions table.

Code example: **BOS-P12W-L1H-W-E927-0**

Body Finish	Output	Voltage	Dimming	Baffles	Beam Angle	CRI	Color Temp	Emergency
B Black	L ² 480lm/ft (5W)	1 120V	H Non Dim	W Flat White	S 10°	9 +90	27 2700K	0 No
G Grey	M ² 835lm/ft (10W)	U ⁵ Universal 120 to 277V	I 0-10V to 1%	B Flat Black	M 20°		30 3000K	9 90 mins
W White	H ² 1170lm/ft (15W)		K Dali to 1%	N Black Nickel	F 28°		35 3500K	
X Custom RAL	V ² 1515lm/ft (20W)		L ELV	C Specular Chrome	B 50°		40 4000K	
	D ³ 455lm/ft (9W)		M DMX	E Diffuse Gold	E 10°x 28°		WD 3000K-1800K	
	W ³ 1300lm/ft (18W)		N ⁶ LUTRON	X Custom	G 10°x 36°		TW 2700K - 5000K	
	U ⁴ 710lm/ft (10W)							
	A ⁴ 1300lm/ft (20W)							

Notes:
¹ 6" length increments available as a modification.
² Denotes output at 3000K, unless otherwise noted.
³ Denotes output specific to Dim-to-Warm at 3000K.
⁴ Denotes output specific to Tunable White at full on.
⁵ Not applicable for ELV dimming.
⁶ Hi-lume, Vive, and Athena compatible.

Consult factory for lead-times.
 Consult factory for systems using multiple optics and mounting configurations.



Bold Lighting
 4710 Ecton Dr., Marietta, GA 30066, USA
 info@boldlighting.us www.boldlighting.us t: +1-678-903-4061

OPTICAL FLEXIBILITY

NARROW BEAM SYMMETRICAL BAFFLE

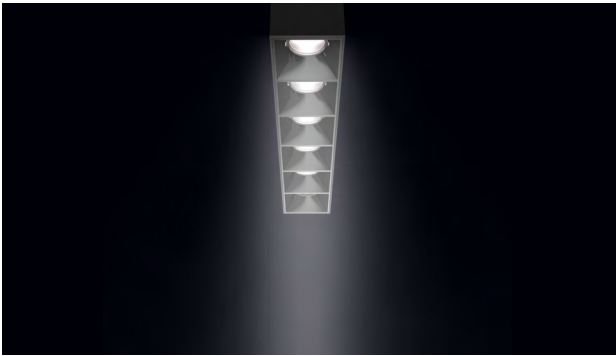

10° Beam Angle

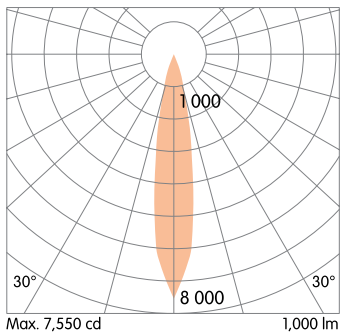

A narrow 10° beam is ideal for high-ceiling applications and for emphasizing texture on vertical surfaces and architectural elements.

MEDIUM BEAM SYMMETRICAL BAFFLE



25° Beam Angle

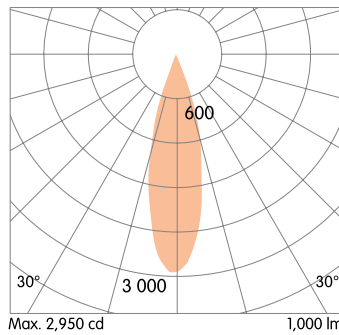

The 25° medium beam is a versatile distribution that works in a wide range of applications and spaces. This optic is a nice balance between light punch and ambient uniformity.

FLOOD BEAM SYMMETRICAL BAFFLE



40° Beam Angle

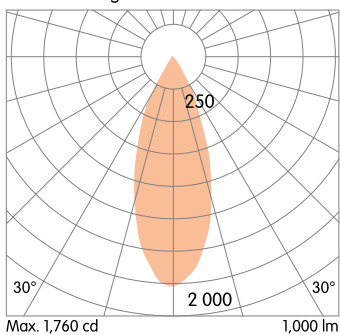

A 40° flood beam is the optimal option for achieving efficient ambient lighting with excellent uniformity and very low glare.

ELLIPTICAL DISTRIBUTION



Elliptical Beam Angle

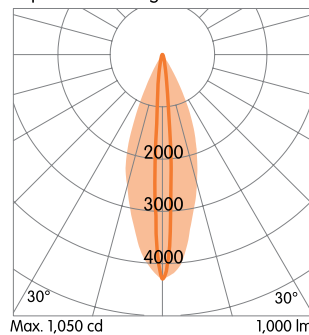

Elliptical distributions can be used anywhere focused illumination is needed. Billet's elliptical beam is ideal for applications such as grazing texture on vertical surfaces and illuminating long narrow spaces without scallops.

MOUNTING FLEXIBILITY

SURFACE MOUNTED



Actual
 L= 24^{1/2}" | 36^{5/16}" | 48^{1/8}" | 59^{5/16}" |
 Continuous runs
 W= 2^{13/16}"
 H= 3^{9/16}"

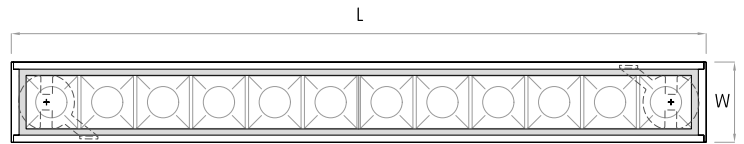
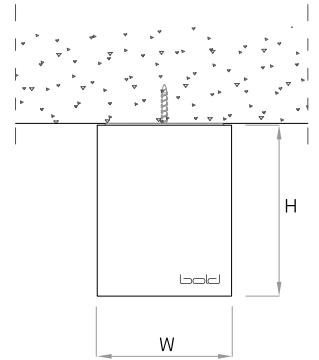

RECESSED WITH TRIM

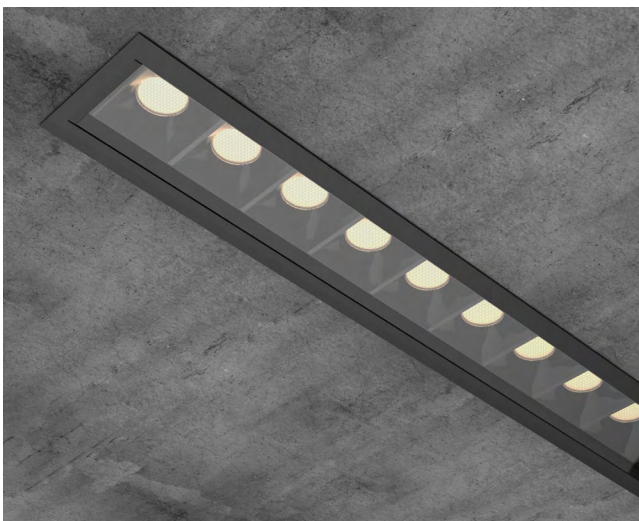

(L-^{13/16}" x W-^{13/16}")

Actual
 L= 13^{3/16}" | 25" | 36^{13/16}" |
 48^{5/8}" | 60^{7/16}" |
 Continuous runs
 W= 3^{7/16}"
 H= 3^{9/16}"

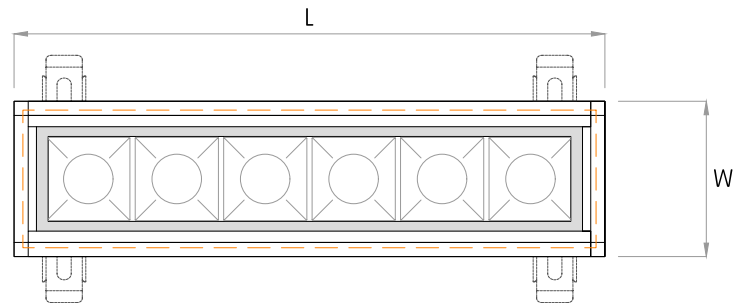
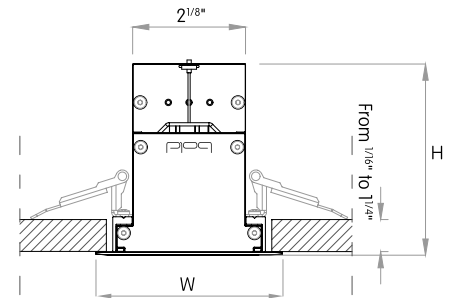

MOUNTING FLEXIBILITY

RECESSED TRIMLESS



 ($L+1/16''$ x $W+1/16''$)

Actual
 $L = 24^{5/8}''$ | $36^{3/8}''$ | $48^{1/4}''$ | $60''$ |
 Continuous runs
 $W = 2^{15/16}''$
 $H = 3^{13/16}''$

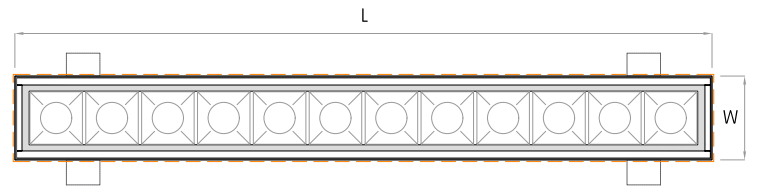
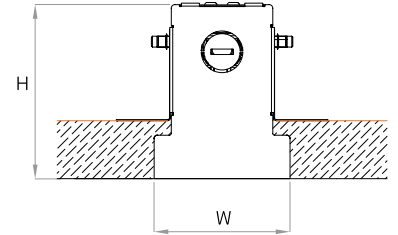

INGROUND

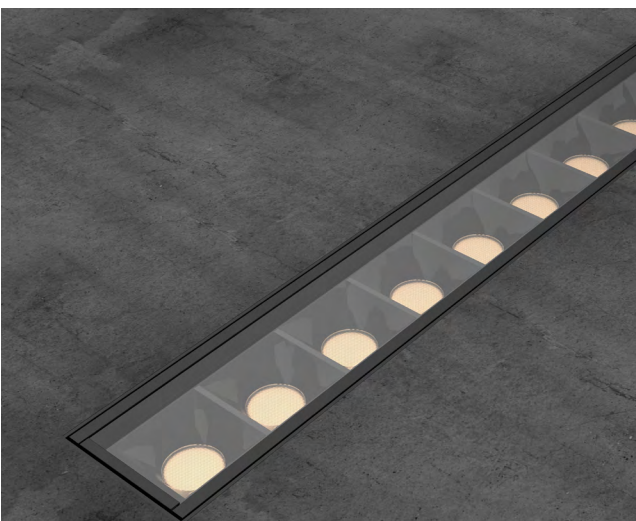

Actual
 $L = 12^{13/16}''$ | $24^{5/8}''$ | $36^{7/16}''$ |
 $48^{1/4}''$ | $60''$ |
 Continuous runs
 $W1 = 3''$ | $W2 = 3^{3/4}''$
 $H = 3^{5/8}''$

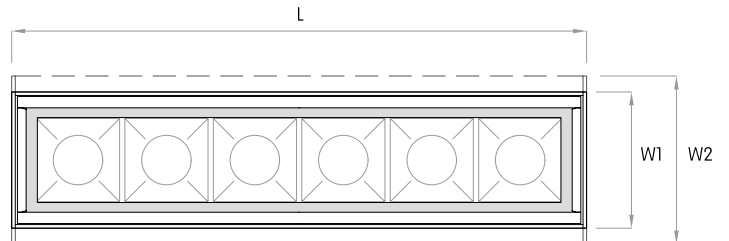
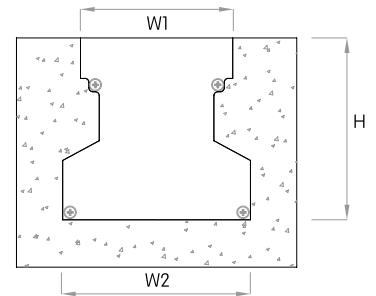

MOUNTING FLEXIBILITY

PENDANT



Actual

L= 24¹/₂" | 36⁵/₁₆" | 48¹/₈" | 59¹⁵/₁₆" |

Continuous runs

W= 2¹³/₁₆"

H= 3⁹/₁₆"

X= 59"

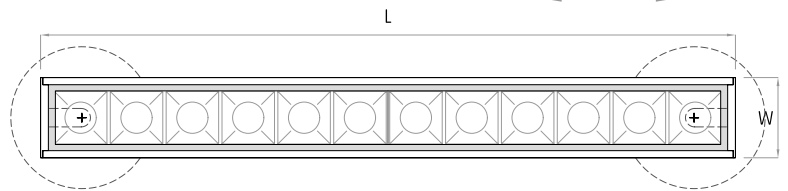
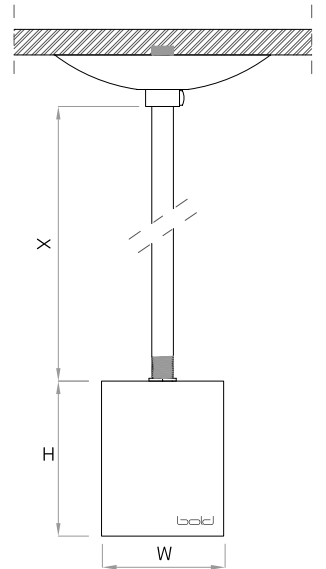

DELIVERED LUMEN OUTPUT

Per Linear Foot

Output Watts CRI +90

STATIC-WHITE		2700K	3000K	3500K	4000K
L	5W	420 lm	480 lm	455 lm	465 lm
M	10W	785 lm	835 lm	850 lm	865 lm
H	15W	1145 lm	1170 lm	1240 lm	1260 lm
V	20W	1470 lm	1515 lm	1590 lm	1620 lm

DIM-TO-WARM 3000K-1800K		3000K			
D	9W	455 lm			
W	18W	1300 lm			

TUNABLE WHITE 2700K-5000K		2700K	5000K		
U	10W	710 lm	710 lm		
A	20W	1300 lm	1300 lm		

DIMENSIONS TABLE

		12"		24"		36"		48"		60"				
		Height		Width		Actual Length								
Surface Mounted	mm	inch	mm	inch	mm	inch	mm	inch	mm	inch	mm	inch	mm	inch
		91	3 9/16	72	2 13/16			622	24 1/2	922	36 5/16	1222	48 1/8	1522
Recessed with Trim	91	3 9/16	88	3 7/16	335	13 3/16	634	25	934	36 13/16	1234	48 5/8	1534	60 7/16
Recessed Trimless	97	3 13/16	75	2 15/16			624	24 5/8	924	36 3/8	1224	48 1/4	1524	60
Pendant	91	3 9/16	72	2 13/16			622	24 1/2	922	36 5/16	1222	48 1/8	1522	59 15/16
Inground (with housing)	92	3 5/8	95	3 3/4	325	12 13/16	625	24 5/8	925	36 7/16	1225	48 1/4	1525	60

