

BILLET

WALLWASHER INTEGRAL - WET LOCATION

bold
lighting



The Billet family of products allows you to achieve uniformity throughout indoor and outdoor spaces while maintaining the same optical performance, light consistency, and overall aesthetics.

The Billet Wallwasher delivers unmatched vertical illumination with virtually zero glare. The Billet confidently delivers a flawless light distribution and a beautifully finished product.

CONSTRUCTION

Product Type : Linear
Body Material : Extruded Aluminum
Body Finish : Black / Grey / White
 Custom RAL
IP Rating : IP67 Inground
 IP66 Ceiling Recessed
IK Rating : IK10
Drive Over Rating : Billet Inground is designed to bear static loads up to 2500 lbs. from vehicles with pneumatic tires. This product is not intended to be used for traffic lanes. Chicago plenum rated

OPTICS

Optical Distribution : Wallwash

LIGHT SOURCE

Direct Light Source : Hi-power LEDs
Luminous Output : from 330lm/ft. to 1265lm/ft. (Delivered)
Light Source CCT : 2700K / 3000K / 3500K
 4000K / Tunable White (2700K-5000K)
 Dim-to-Warm (3000K-1800K) / RGBW
Color Rendering Index : Ra90
Lifetime : L80 B10 @ 70,000 Hrs

ELECTRICAL

Input Voltage : 120V / UNV 120-277V - 50Hz/60Hz
Load : 5W/ft. to 20W/ft.
Output Type : Constant Current
Driver Type : Integral
Dimming : 0-10V / DALI / ELV / DMX / Lutron Hi-Lume
Code Compliance : ETL / CSA / CE

INSTALLATION

Environment : Wet Location
Mounting : Inground / Ceiling Recessed (Trim & Trimless) / Wall Recessed (Trim & Trimless) / Surface Mounted Wall Mounted / Pendant

Code example: **BOW** - P12W - L1B - W - W927 - 0

Series	Mounting	Nominal Length ¹
BOW	R Recessed with Trim	12 12"
	T Recessed Trimless*	24 24"
	S Surface Mounted	36 36"
	P Pendant	48 48"
	I Inground*	60 60"
	W Wall Mounted	XX Custom in
	*For Inground "I" and Recessed Trimless "T" mountings, the housings will show on the price quote and order as a separate item to allow us to ship them ahead of the fixtures if required by the contractor.	

Body Finish	Output	Voltage	Dimming	Baffles	Beam Angle	CRI	Color Temp	Emergency
B Black	L² 375lm/ft (5W)	1 120V	A No Dimming	W Flat White	W Washer	9 +90	27 2700K	0 No
G Grey	M² 650lm/ft (10W)	U⁶ Universal 120 to 277V	B 0-10V to 1%	B Flat Black			30 3000K	
W White	H² 915lm/ft (15W)		D DALI to 1%	N Black Nickel			35 3500K	
X Custom RAL	V² 1180lm/ft (20W)		E ELV Dimming	C Specular Chrome			40 4000K	
	D³ 355lm/ft (9W)		F DMX	E Diffuse Gold			WD 3000K-1800K	
	W³ 1015lm/ft (18W)		G⁷ LUTRON	X Custom			TW 2700K - 5000K	
	U⁴ 555lm/ft (10W)						CC⁸ RGBW	
	A⁴ 1015lm/ft (20W)							
C⁵ 855lm/ft (20W)								

Notes:
¹ 6" length increments available as a modification.
² Denotes output at 3000K, unless otherwise noted.
³ Denotes output specific to Dim-to-Warm at 3000K.
⁴ Denotes output specific to Tunable White at full on.
⁵ Denotes RGBW (C) output with all colors at full power.
⁶ Not applicable for ELV dimming.
⁷ Hi-lume, Vive, and Athena compatible.
⁸ Only available with DMX dimming.

Consult factory for lead-times.
 Consult factory for systems using multiple optics and mounting configurations.



Bold Lighting
 4710 Ecton Dr., Marietta, GA 30066, USA
 info@boldlighting.us www.boldlighting.us t: +1-678-903-4061

OPTICAL FLEXIBILITY

BAFFLED WALLWASHER



Billet wallwash provides even illumination of vertical surfaces with a flexible setback of 1/8 to 1/6 of the wall height. This optic is ideal for washing large areas where exceptional uniformity is required.

Wallwasher

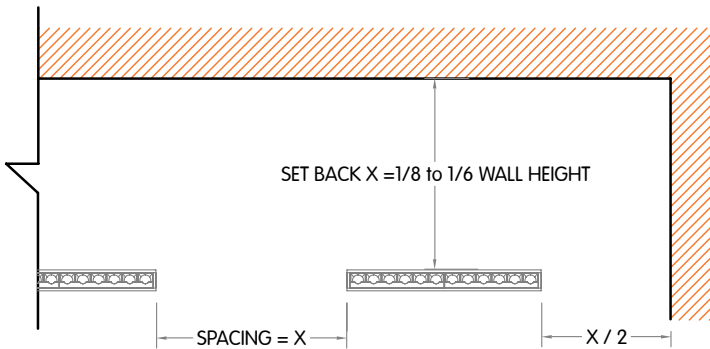
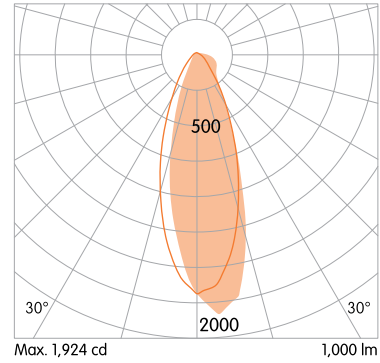

MOUNTING FLEXIBILITY

SURFACE MOUNTED



Actual
 L= 24¹/₂" | 36⁵/₁₆" | 48¹/₈" | 59⁵/₁₆" |
 Continuous runs
 W= 2¹³/₁₆"
 H= 3⁹/₁₆"

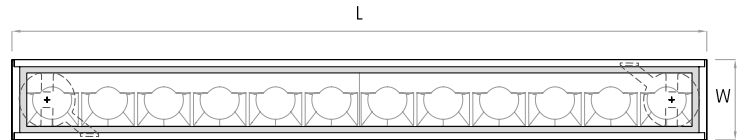
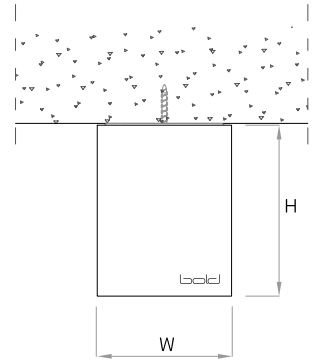

RECESSED WITH TRIM



(L-¹³/₁₆" x W-¹³/₁₆")

Actual
 L= 13³/₁₆" | 25" | 36¹³/₁₆" |
 48⁵/₈" | 60⁷/₁₆" |
 Continuous runs
 W= 3⁷/₁₆"
 H= 3⁹/₁₆"

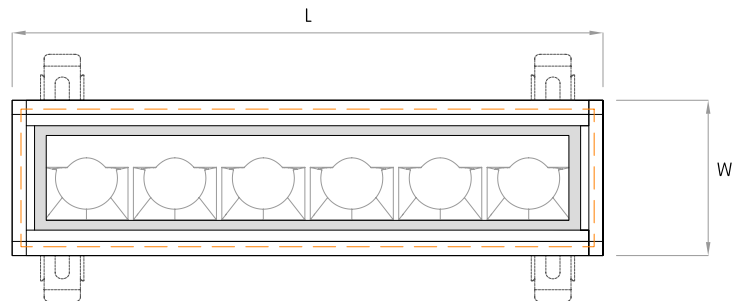
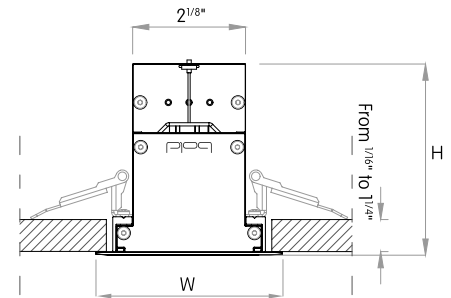

MOUNTING FLEXIBILITY

RECESSED TRIMLESS



$$\text{Trimless} (L + 1/16" \times W + 1/16")$$

Actual
 $L = 24^{5/8}" \mid 36^{3/8}" \mid 48^{1/4}" \mid 60"$
 Continuous runs
 $W = 2^{15/16}"$
 $H = 3^{13/16}"$

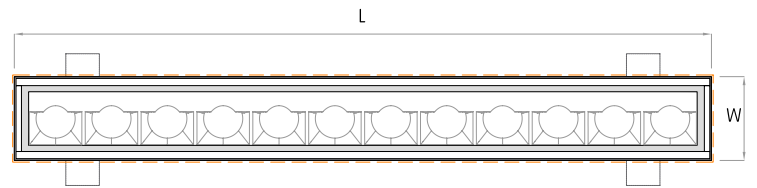
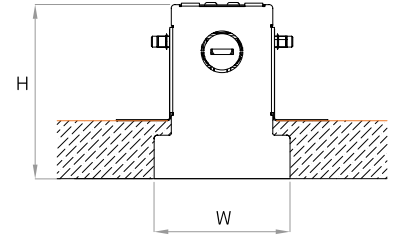

INGROUND

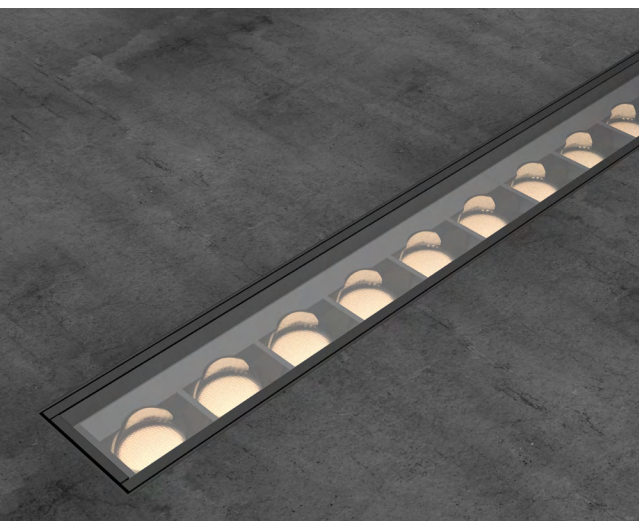

Actual
 $L = 12^{13/16}" \mid 24^{5/8}" \mid 36^{7/16}" \mid 48^{1/4}" \mid 60"$
 Continuous runs
 $W1 = 3" \mid W2 = 3^{3/4}"$
 $H = 3^{5/8}"$

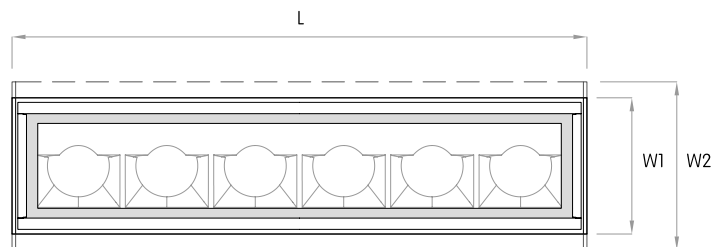
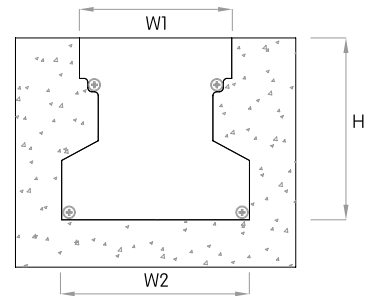

MOUNTING FLEXIBILITY

PENDANT



Actual
 L= 24¹/₂" | 36⁵/₁₆" | 48¹/₈" | 59¹⁵/₁₆" |
 Continuous runs
 W= 2¹³/₁₆"
 H= 3⁹/₁₆"
 X= 59"

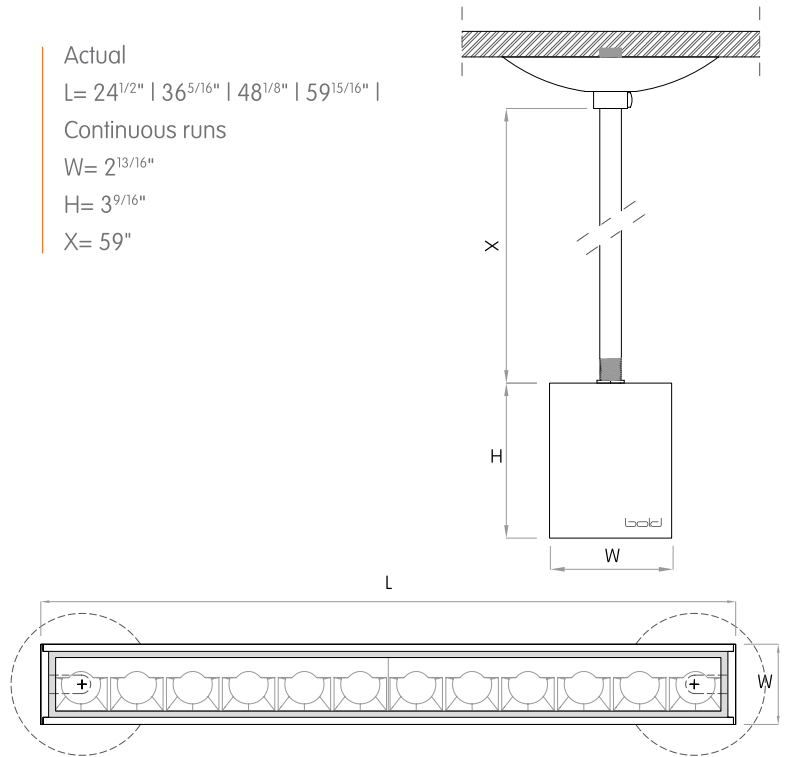

WALL MOUNTED



Actual
 L= 24¹/₂" | 36⁵/₁₆" | 48¹/₈" | 59¹⁵/₁₆" |
 Continuous runs
 W= 2¹³/₁₆"
 H= 3⁹/₁₆"

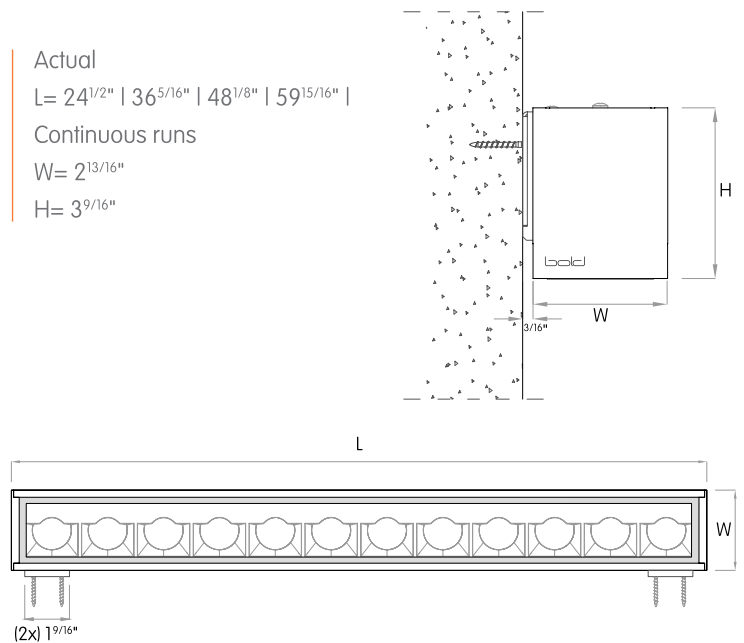

DELIVERED LUMEN OUTPUT

Per Linear Foot

Output Watts CRI +90

STATIC-WHITE		2700K	3000K	3500K	4000K
L	5W	330 lm	375 lm	355 lm	360 lm
M	10W	615 lm	650 lm	665 lm	675 lm
H	15W	895 lm	915 lm	965 lm	985 lm
V	20W	1150 lm	1180 lm	1240 lm	1265 lm

DIM-TO-WARM 3000K-1800K		3000K			
D	9W	355 lm			
W	18W	1015 lm			

TUNABLE WHITE 2700K-5000K		2700K	5000K		
U	10W	555 lm	555 lm		
A	20W	1015 lm	1015 lm		

RGBW		R	G	B	W
TOTAL	20W	525 lm	855 lm	130 lm	815 lm

DIMENSIONS TABLE

		12"		24"		36"		48"		60"				
		Height		Width		Actual Length								
Surface Mounted	mm	Inch	mm	Inch	mm	Inch	mm	Inch	mm	Inch	mm	Inch		
		91	3 9/16	72	2 13/16			622	24 1/2	922	36 5/16	1222	48 1/8	1522
Recessed with Trim	91	3 9/16	88	3 7/16	335	13 3/16	634	25	934	36 13/16	1234	48 5/8	1534	60 7/16
Recessed Trimless	97	3 13/16	75	2 15/16			624	24 5/8	924	36 3/8	1224	48 1/4	1524	60
Pendant	91	3 9/16	72	2 13/16			622	24 1/2	922	36 5/16	1222	48 1/8	1522	59 15/16
Inground (with housing)	92	3 5/8	95	3 3/4	325	12 13/16	625	24 5/8	925	36 7/16	1225	48 1/4	1525	60
Wall Mounted	91	3 9/16	72	2 13/16			622	24 1/2	922	36 5/16	1222	48 1/8	1522	59 15/16

