

BILLET

STEALTH REFLECTOR REMOTE - WET LOCATION

bold
lighting

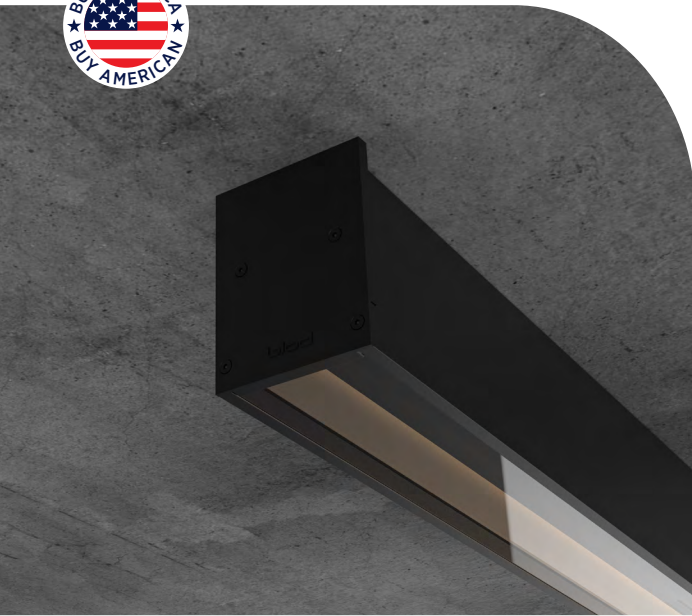

The Billet Stealth product is a natural expansion of the indirect performance optics range developed by Bold to enhance visual comfort. The Stealth offers an outstanding wallwash illumination with virtually zero glare. The outstanding uniformity of the wallwash effect translates in a 3:1 max. to min. illumination ratio. Its 100% indirect light optic ensures a complete shielding of its light source. This proprietary optic allows a vertical illumination starting at the Zero point of the fixture while maintaining a flush position of the optic.

Stealth offers a minimalistic aesthetic with its 1" continuous slot and the ability to have the flush light shield and the interior of the fixture in various finishes and colors to match any required surface. This proprietary optic promotes humancentric lighting with its glare-free attributes.

CONSTRUCTION

Product Type : Linear

Body Material : Extruded Aluminum

Body Finish : Black / Grey / White
Custom RAL

IP Rating : IP65 / IP67

IK Rating : IK10

Drive Over Rating : Billet Inground is designed to bear static loads up to 2500 lbs. from vehicles with pneumatic tires. This product is not intended to be used for traffic lanes.

Chicago plenum rated

INSTALLATION

Environment : Wet Location

Mounting : Ceiling Recessed (Trim & Trimless) / Millwork / Surface Mounted
Pendant / Inground

Dimensions : Refer to dimension table

OPTICS

Optical Distribution : Wallwash

LIGHT SOURCE

Direct Light Source : Hi-power LEDs
Luminous Output : from 450lm/ft. to 940lm/ft. (Delivered)

Light Source CCT : 2700K / 3000K
3500K / 4000K

Color Rendering Index : Ra90

Lifetime : L80 B10 @ 70,000 Hrs

ELECTRICAL

Input Voltage : UNV 120-277V -
50Hz/60Hz

Load : 10W/ft. to 20W/ft.

Output Type : Constant Voltage

Driver Type : Remote

Dimming : 0-10V / DALI / ELV / DMX /
Lutron Hi-Lume

Code Compliance : ETL / CSA / CE

Series	Mounting	Nominal Length ¹	Body Finish
BOK	R Recessed with Trim	12 12"	W White
	T Recessed Trimless*	24 24"	B Black
	S Surface Mounted	36 36"	G Grey
	P Pendant	48 48"	X Custom RAL
	M Millwork	60 60"	
	I Inground*	XX Custom in	
* For Inground "I" and Recessed Trimless "T" mountings, the housings will show on the price quote and order as a separate item to allow us to ship them ahead of the fixtures if required by the contractor.		For custom lengths and shapes, consult factory. For exact lengths refer to dimensions table.	

Code example: **BOK**-P12W-H11-W-W927-0

Output	Voltage	Dimming	Baffle	Beam Angle	CRI	Color Temp	Emergency
M² 470lm/ft (10W)	1 120V	H Non Dim	W White	W Washer	9 +90	27 2700K	0 No
H² 615lm/ft (15W)	U³ Universal 120 to 277V	I 0-10V to 1%	B Black			30 3000K	9 90 mins
V² 875lm/ft (20W)		K Dali to 1%	G Grey			35 3500K	
		L ELV	X Custom RAL			40 4000K	
		M DMX					
		N⁴ LUTRON					

Notes:

¹ 6" length increments available as a modification.

² Denotes output at 3000K, unless otherwise noted.

³ Not applicable for ELV dimming.

⁴ Hi-lume, Vive, and Athena compatible.

Consult factory for lead-times.

Consult factory for systems using multiple optics and mounting configurations.



Bold Lighting

4710 Ecton Dr., Marietta, GA 30066, USA

info@boldlighting.us www.boldlighting.us t: +1-678-903-4061

OPTICAL FLEXIBILITY

STEALTH WALLWASHER



The Stealth Reflector provides even illumination of vertical surfaces with a flexible set back of 1/5 of the wall height and an offset to spacing ratio of 1:1. Stealth's optics are designed to wash large areas where exceptional uniformity and a quiet ceiling is required.

Stealth Reflector

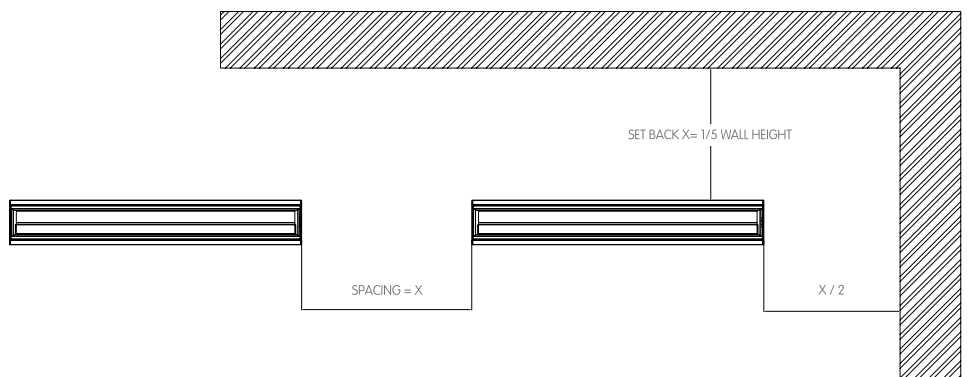
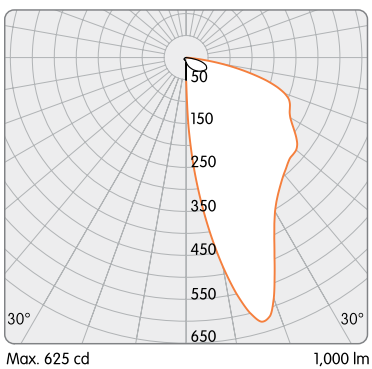

MOUNTING FLEXIBILITY

SURFACE MOUNTED

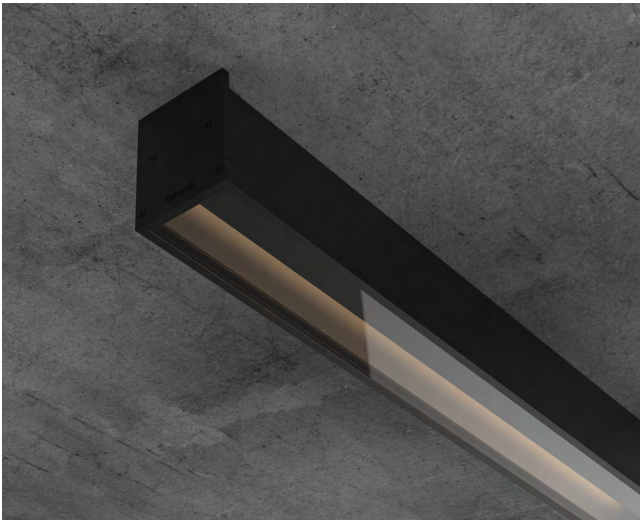

Actual
 L= 24^{1/2}" | 36^{5/16}" | 48^{1/8}" | 59^{5/16}" |
 Continuous runs
 W= 2^{13/16}"
 H= 3^{9/16}"

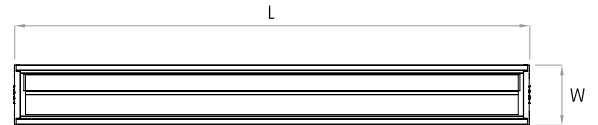
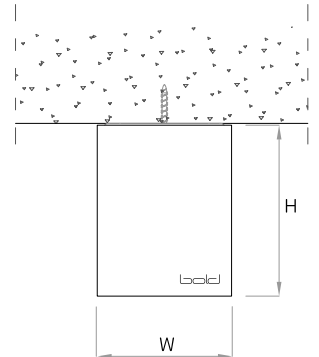

RECESSED WITH TRIM



(L-13^{3/16}" x W-13^{1/16}")

Actual
 L= 13^{3/16}" | 25" | 36^{13/16}" |
 48^{5/8}" | 60^{7/16}" |
 Continuous runs
 W= 3^{7/16}"
 H= 3^{9/16}"

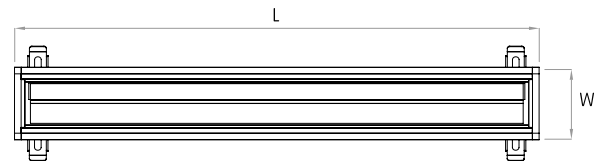
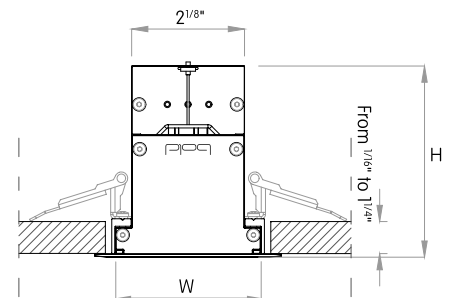

MOUNTING FLEXIBILITY

RECESSED TRIMLESS

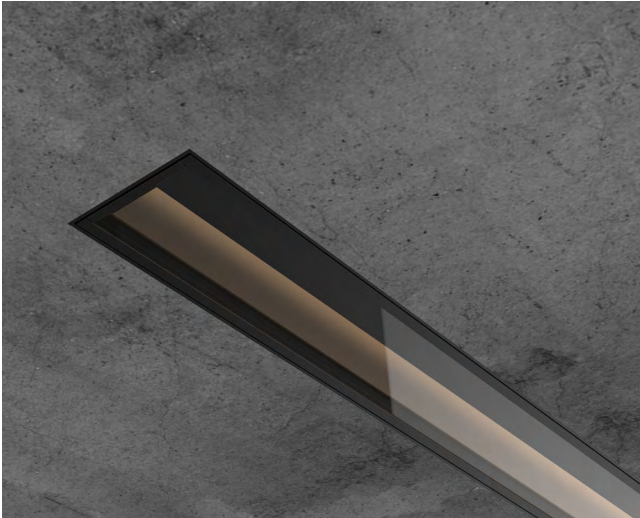

$$\text{Trimless} \quad (L + 1/16" \times W + 1/16")$$

Actual
 $L = 24^{5/8}" \mid 36^{3/8}" \mid 48^{1/4}" \mid 60"$
 Continuous runs
 $W = 2^{15/16}"$
 $H = 3^{13/16}"$

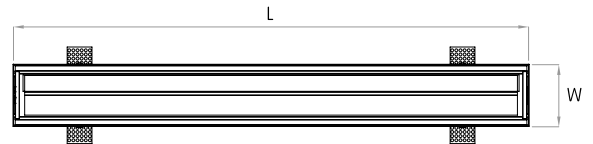
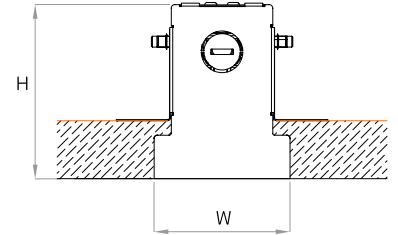

INGROUND

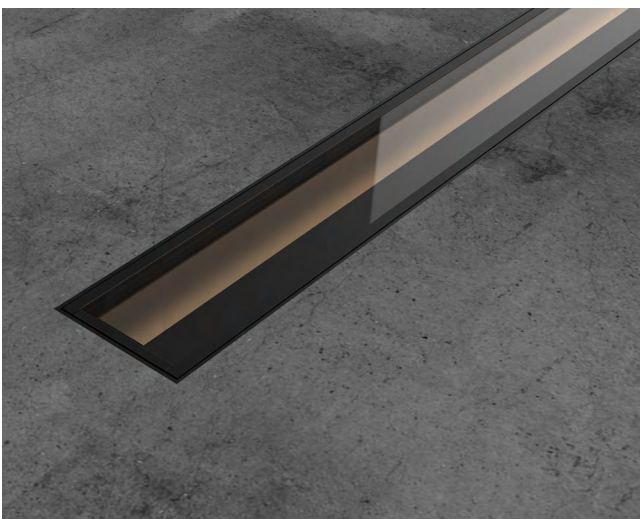

Actual
 $L = 12^{13/16}" \mid 24^{5/8}" \mid 36^{7/16}" \mid 48^{1/4}" \mid 60"$
 Continuous runs
 $W1 = 3" \mid W2 = 3^{3/4}"$
 $H = 3^{5/8}"$

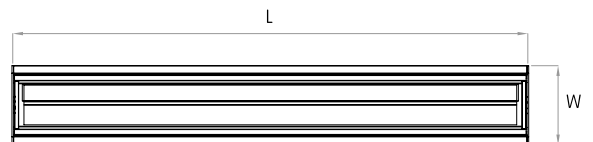
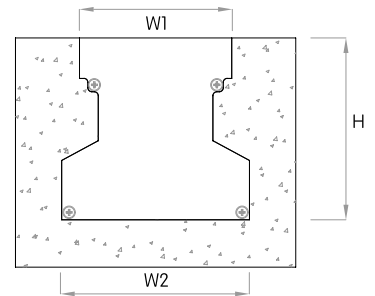

MOUNTING FLEXIBILITY

PENDANT



Actual

L= 24¹/₂" | 36⁵/₁₆" | 48¹/₈" | 59¹⁵/₁₆" |

Continuous runs

W= 2¹³/₁₆"

H= 3⁹/₁₆"

X= 59"

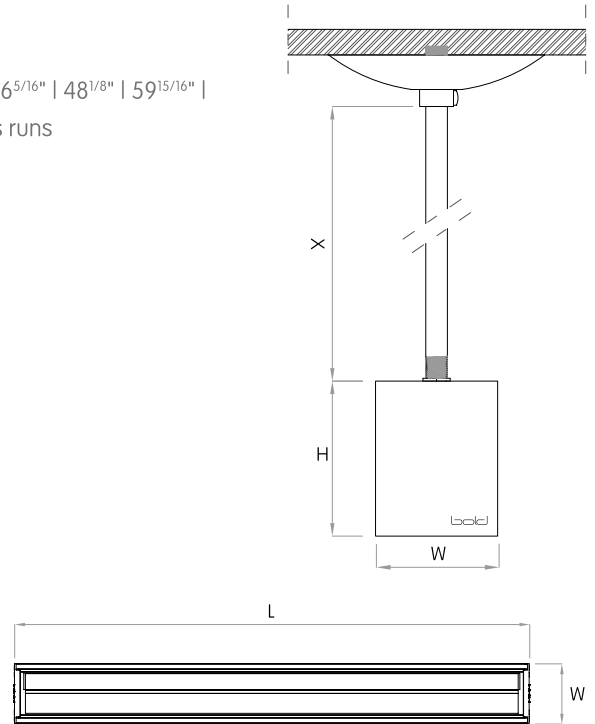

DELIVERED LUMEN OUTPUT

Per Linear Foot

Output Watts CRI +90

STATIC-WHITE		2700K	3000K	3500K	4000K
M	10W	450 lm	470 lm	485 lm	500 lm
H	15W	590 lm	615 lm	635 lm	660 lm
V	20W	840 lm	875 lm	910 lm	940 lm

DIMENSIONS TABLE

				12"		24"		36"		48"		60"			
		Height		Width		Actual Length									
		mm	inch	mm	inch	mm	inch	mm	inch	mm	inch	mm	inch	mm	inch
		Surface Mounted	91	3 9/16	72	2 13/16			622	24 1/2	922	36 5/16	1222	48 1/8	1522
Recessed with Trim	91	3 9/16	88	3 7/16	335	13 3/16	634	25	934	36 13/16	1234	48 5/8	1534	60 7/16	
Recessed Trimless	97	3 13/16	75	2 15/16			624	24 5/8	924	36 3/8	1224	48 1/4	1524	60	
Pendant	91	3 9/16	72	2 13/16			622	24 1/2	922	36 5/16	1222	48 1/8	1522	59 15/16	
Inground (with housing)	92	3 5/8	95	3 3/4	325	12 13/16	625	24 5/8	925	36 7/16	1225	48 1/4	1525	60	

